

#2024 R4M Advanced parts

1



x325

2



x16

3



x9

4



x1

5



x1

6



x30

7



x10

8



x4

9



x10

10



x3

11



x9

12



x6

13



x5

14



x14

15



x10

16



x10

17



x3

18



x3

19



x3

20



x16

21



x16

22



x4

23



x4

24



x4

25



x20

26

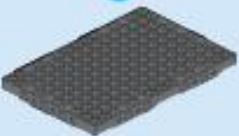

x46

27



x51

28



x8

29



x8

30



x6

31



x6

32



x3

33



x3

34



x1

35



x1

36



x56

37



x8

38



x3

39



x1

40



x1

41



x1

1



x234

14



x14

26

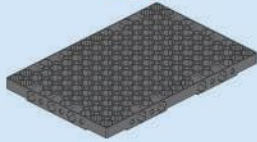

x40

27



x51

41



x1

1 x10

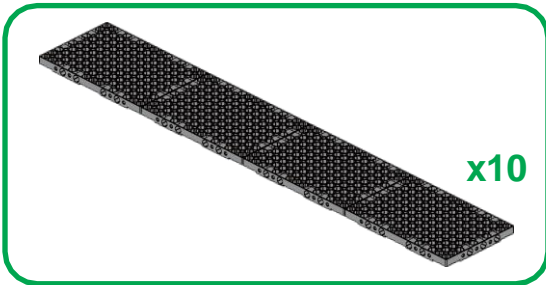
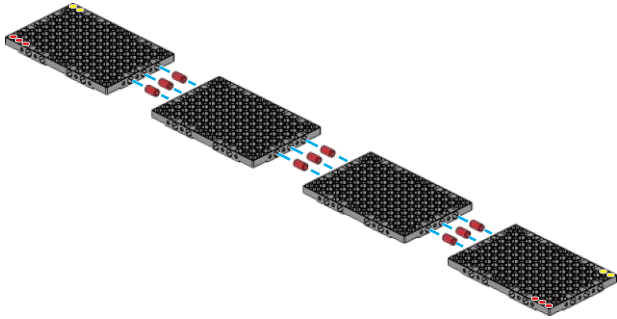
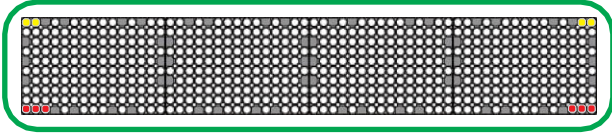

2 x5

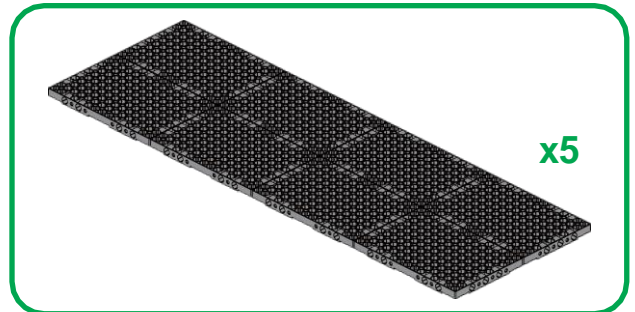
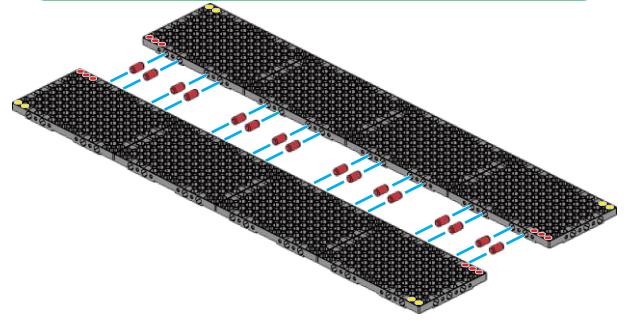
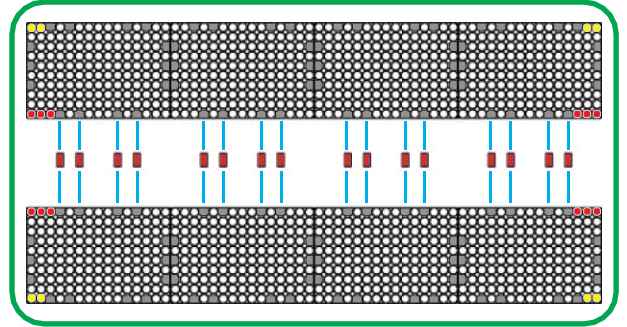

3 x5

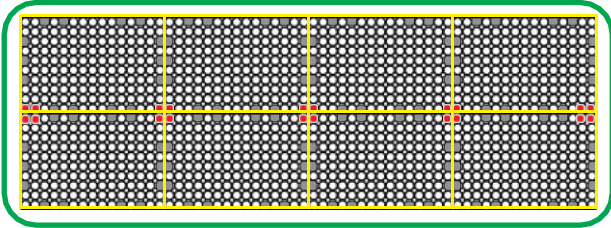

4 x4

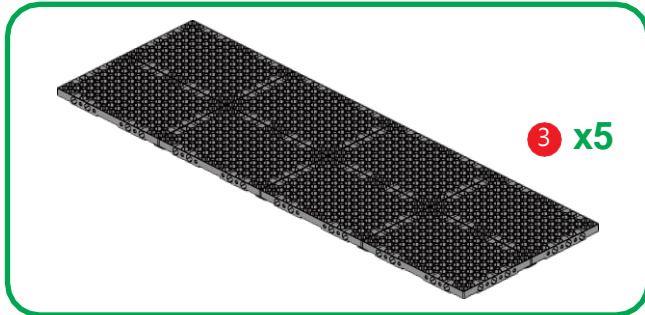
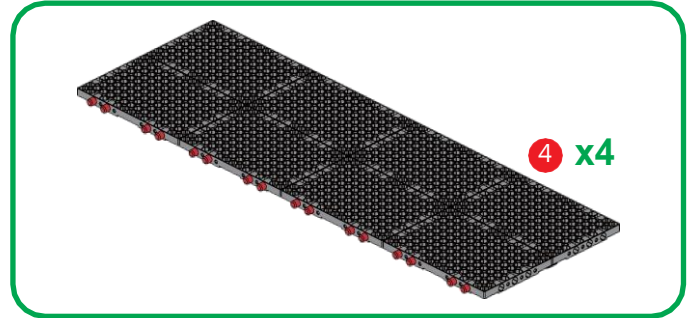
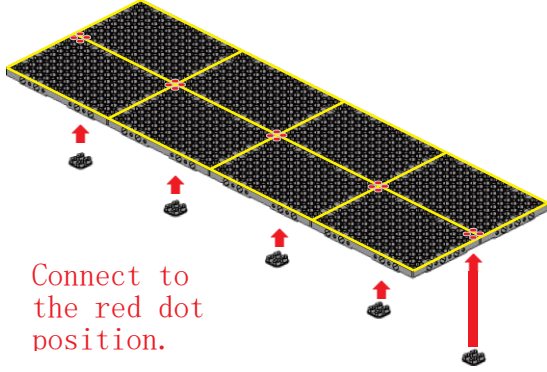
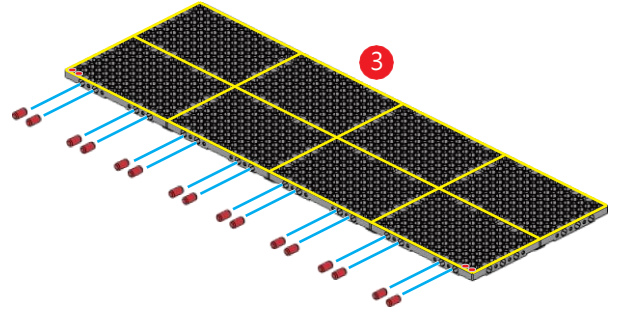

5

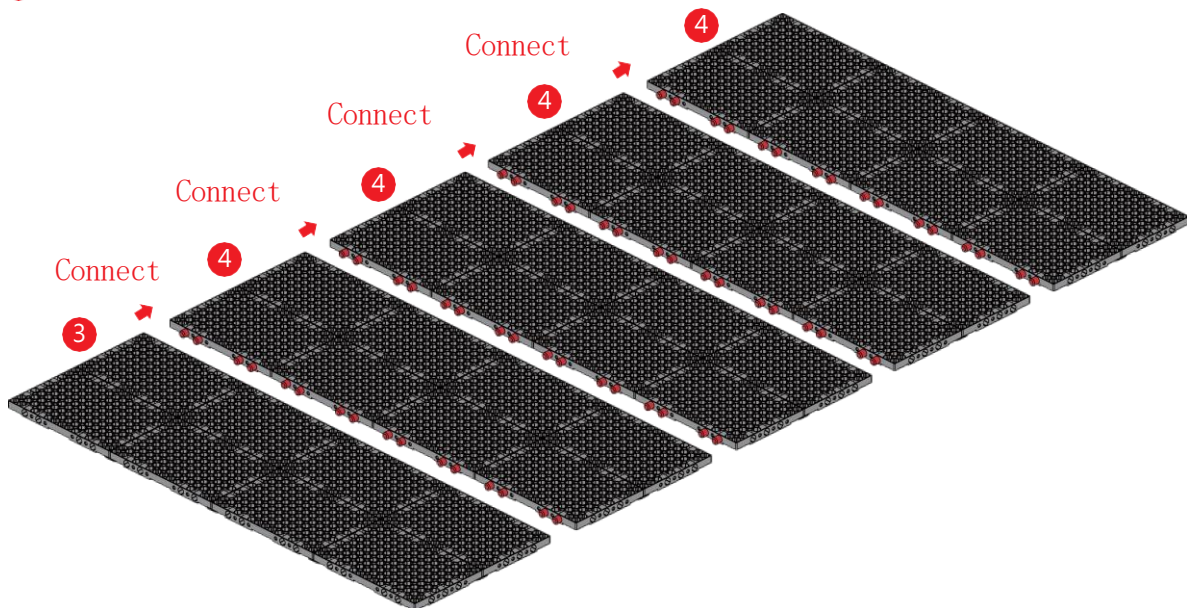

6

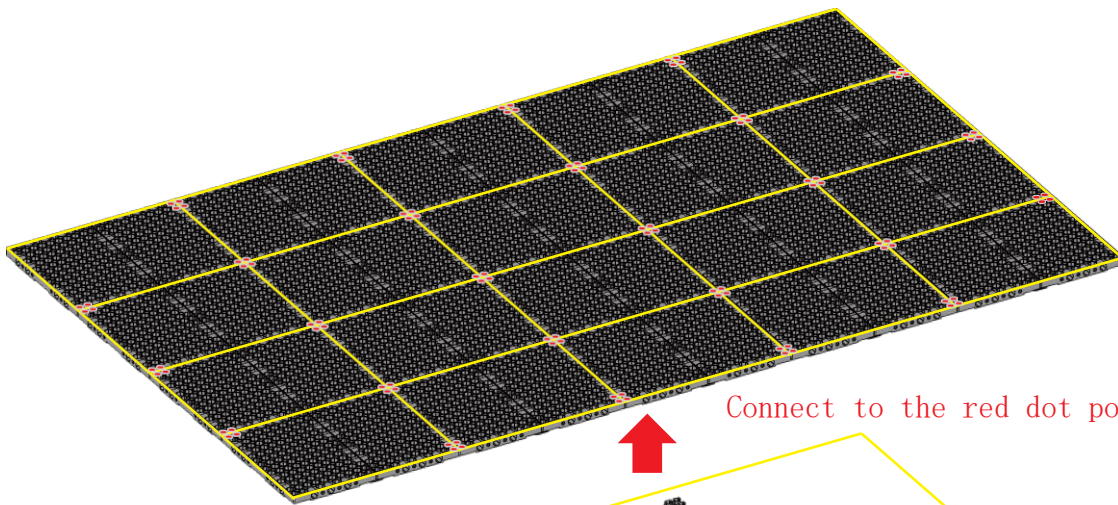
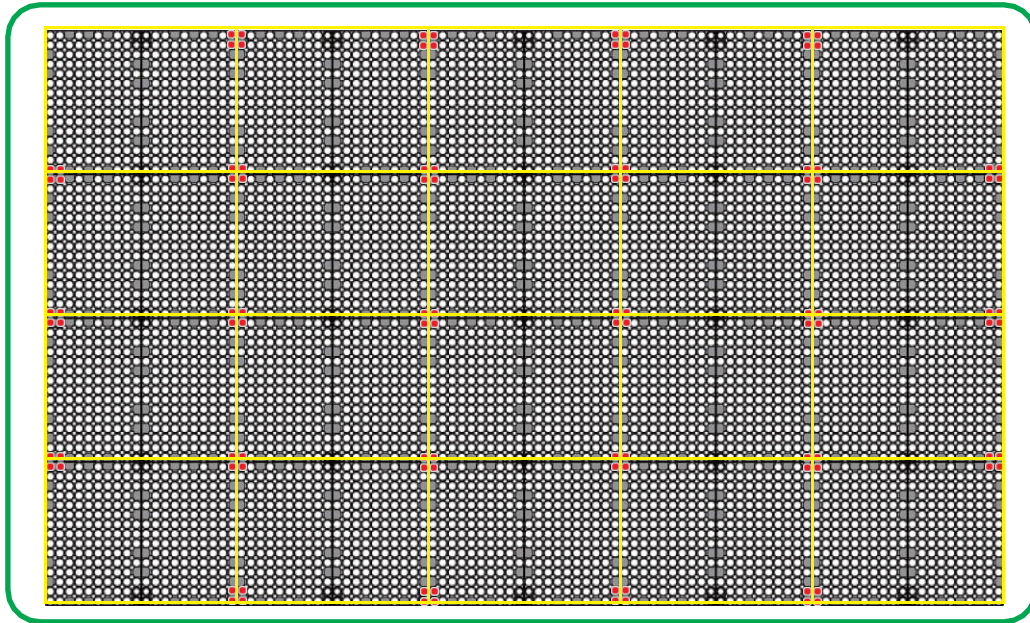

Connect to the red dot position.

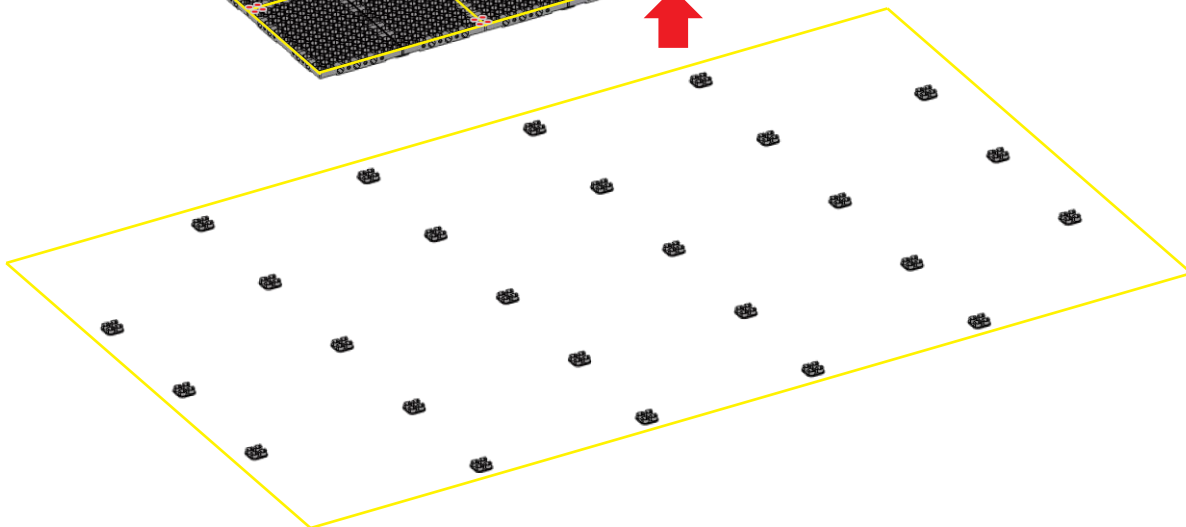

7

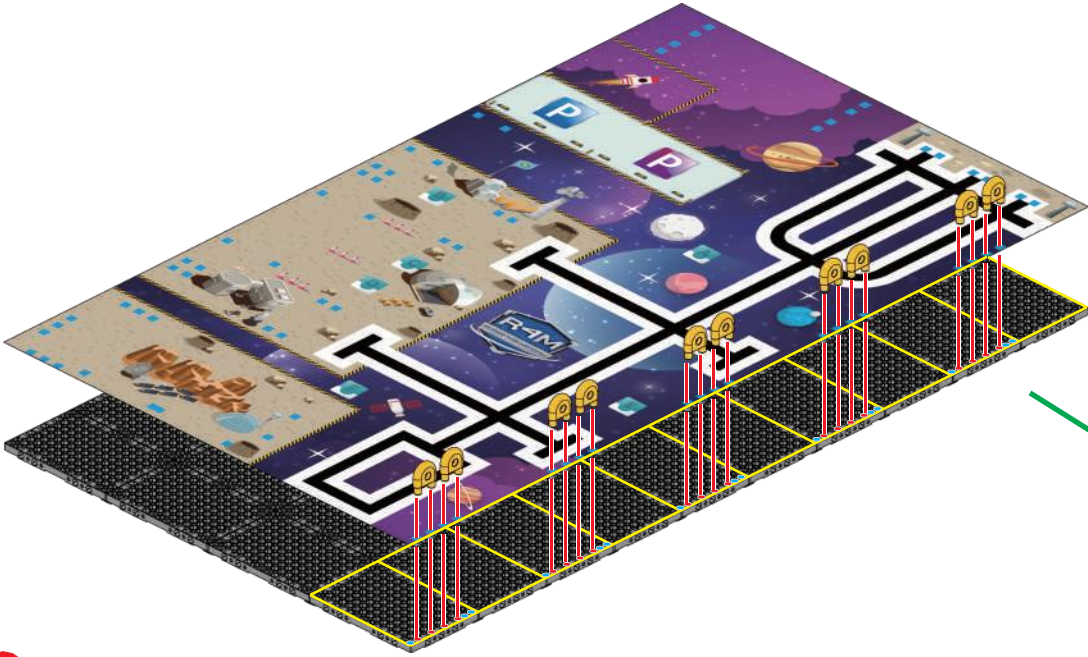

8

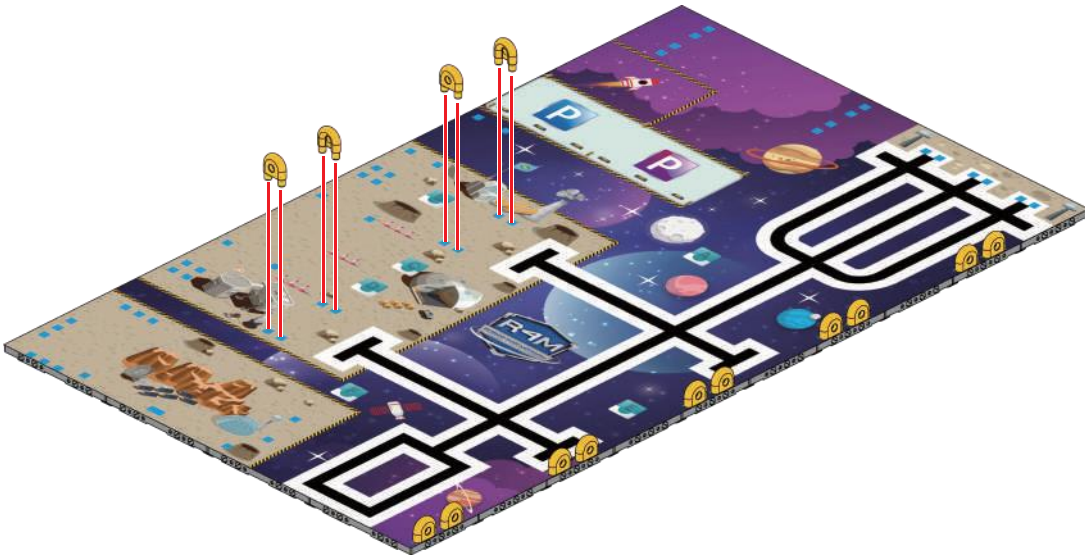

OK

STEP. 1

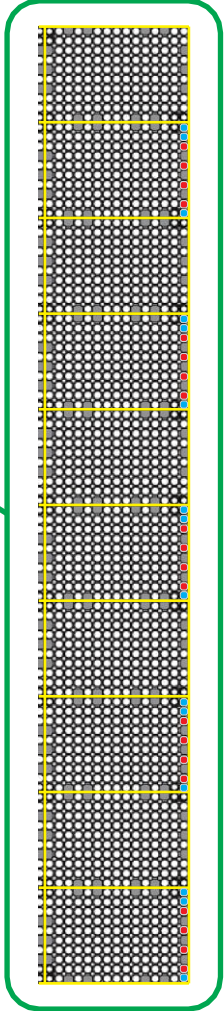

10

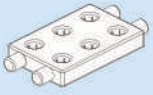

x3

40



x1

1 Paste.

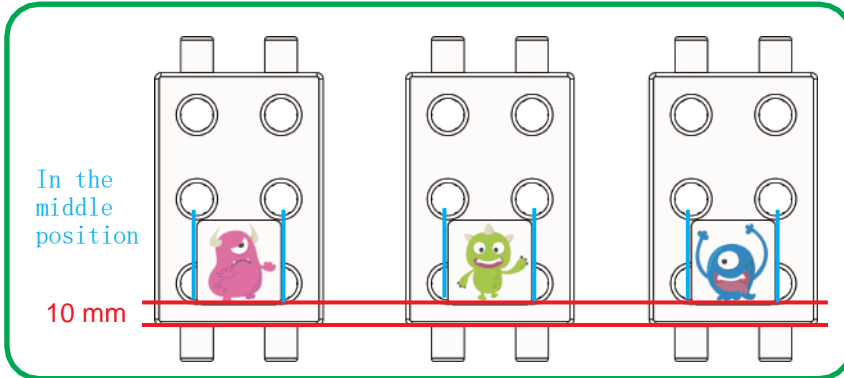
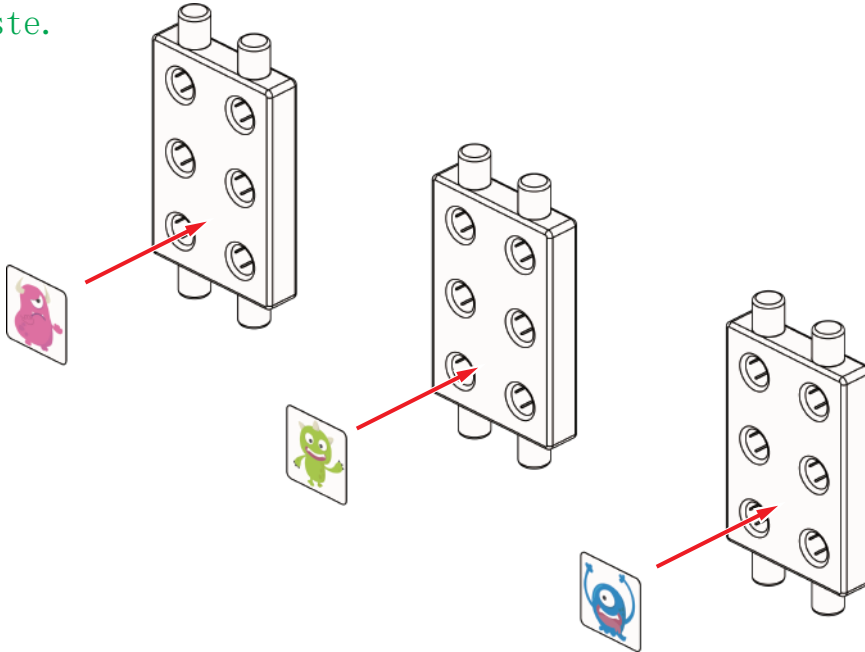

OK STEP. 2

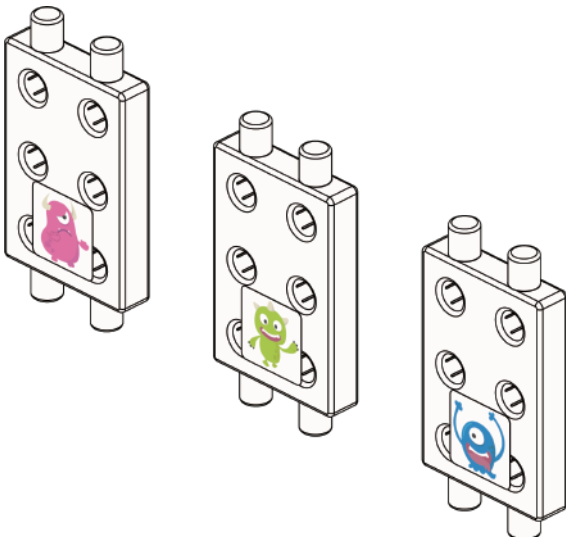

1



x48

2



x12

6



x16

8

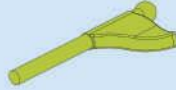

x2

9

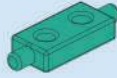

x6

26

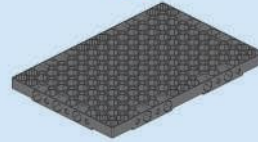

x4

36



x56

1 x28

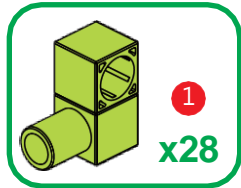
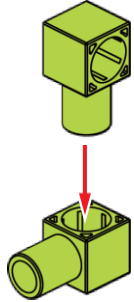

2 x4

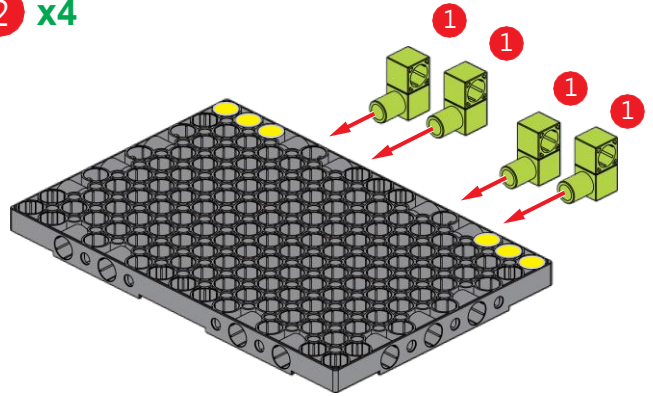

3 x4

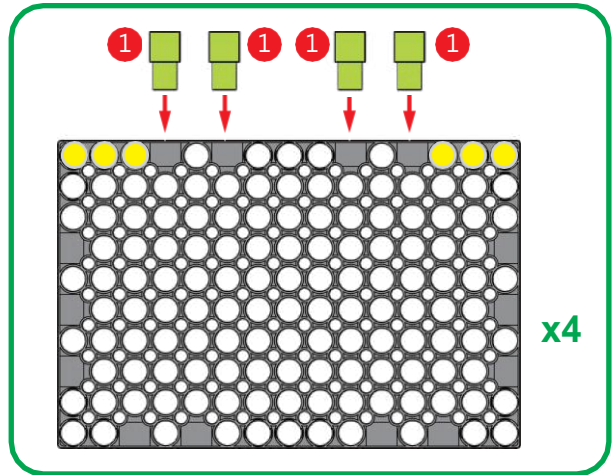
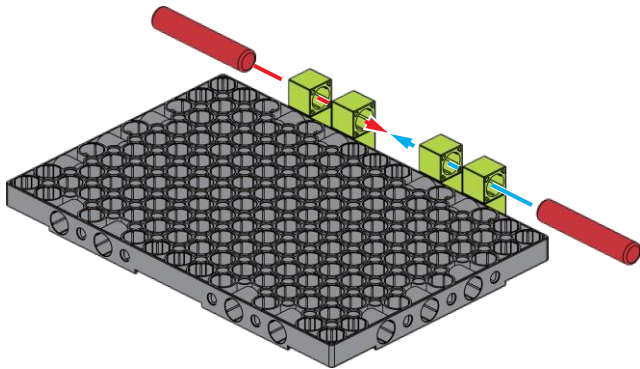

4 x2

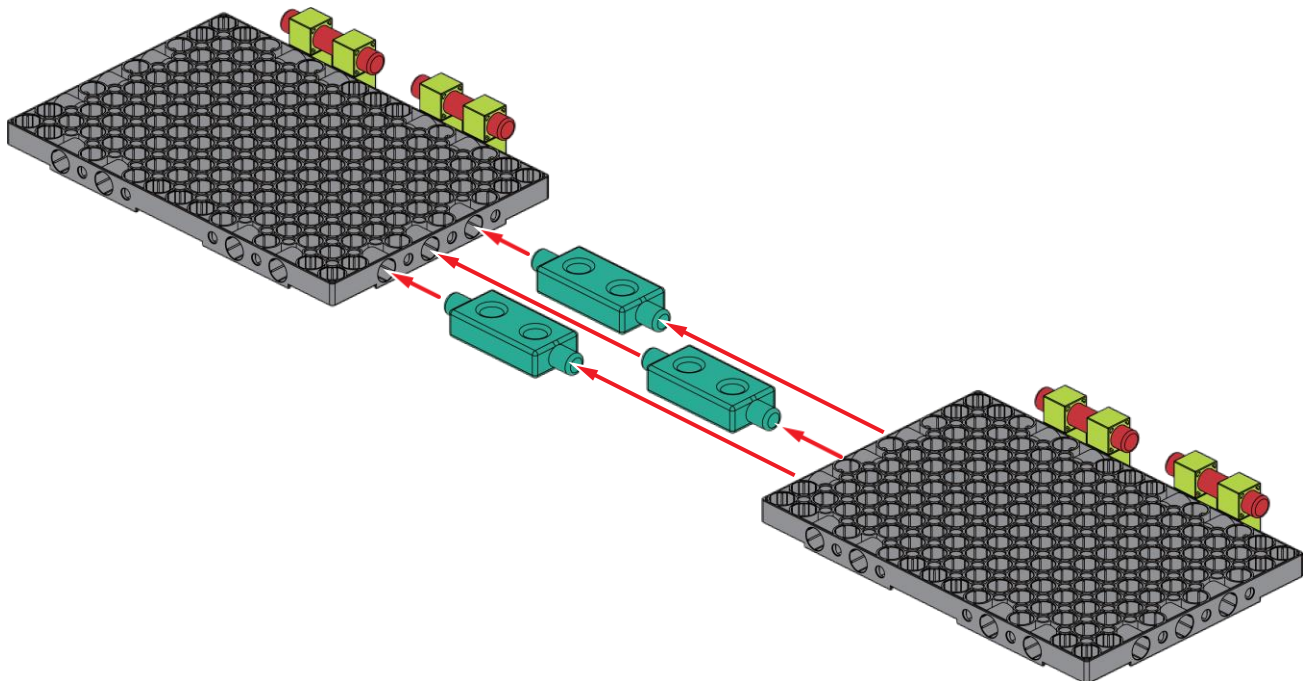

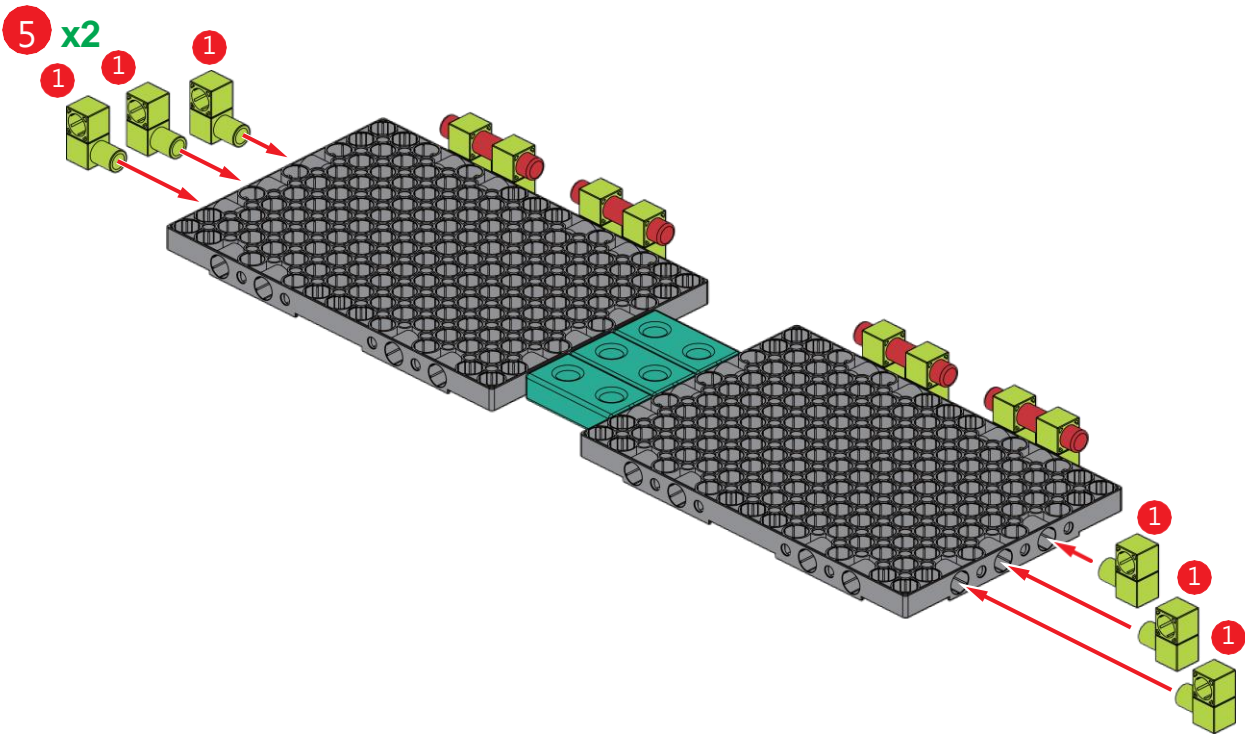

6 x2

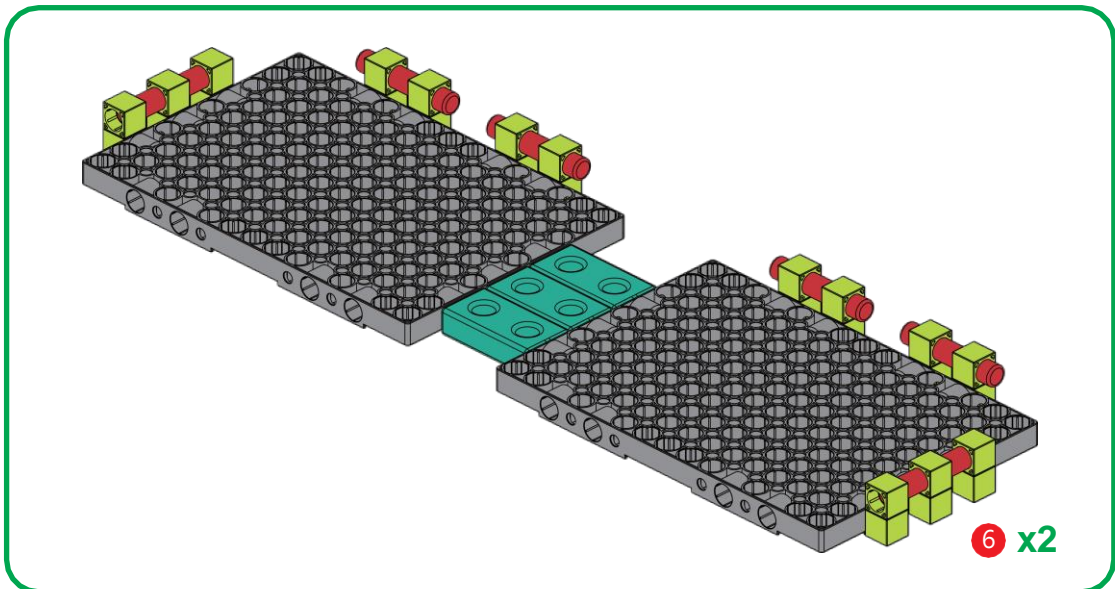
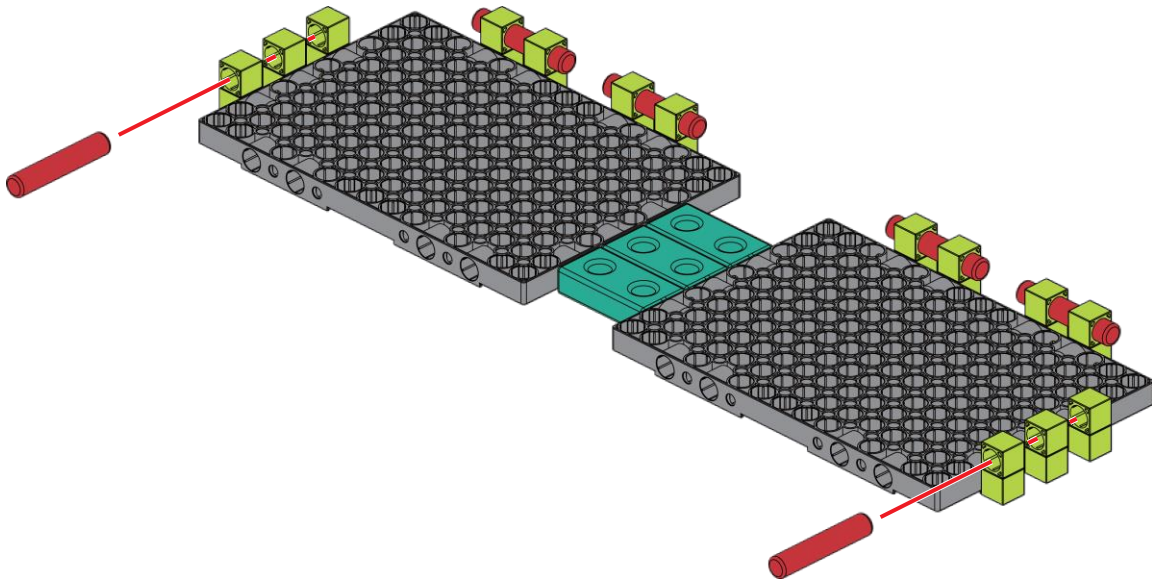

7 x8

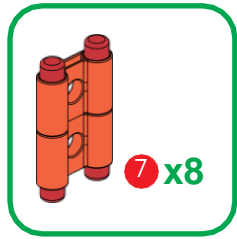
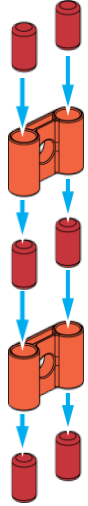

8

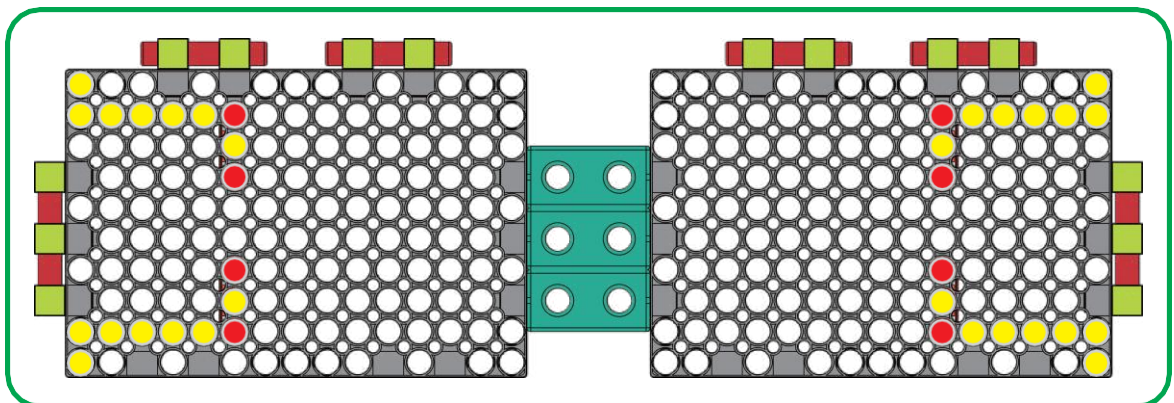
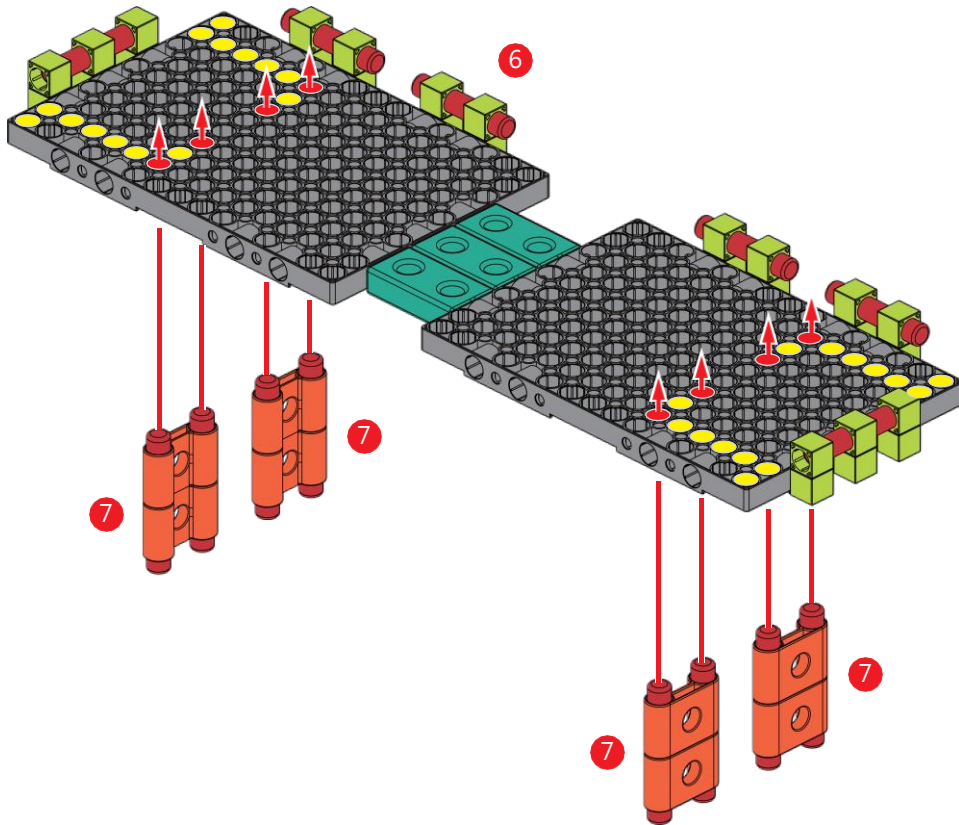

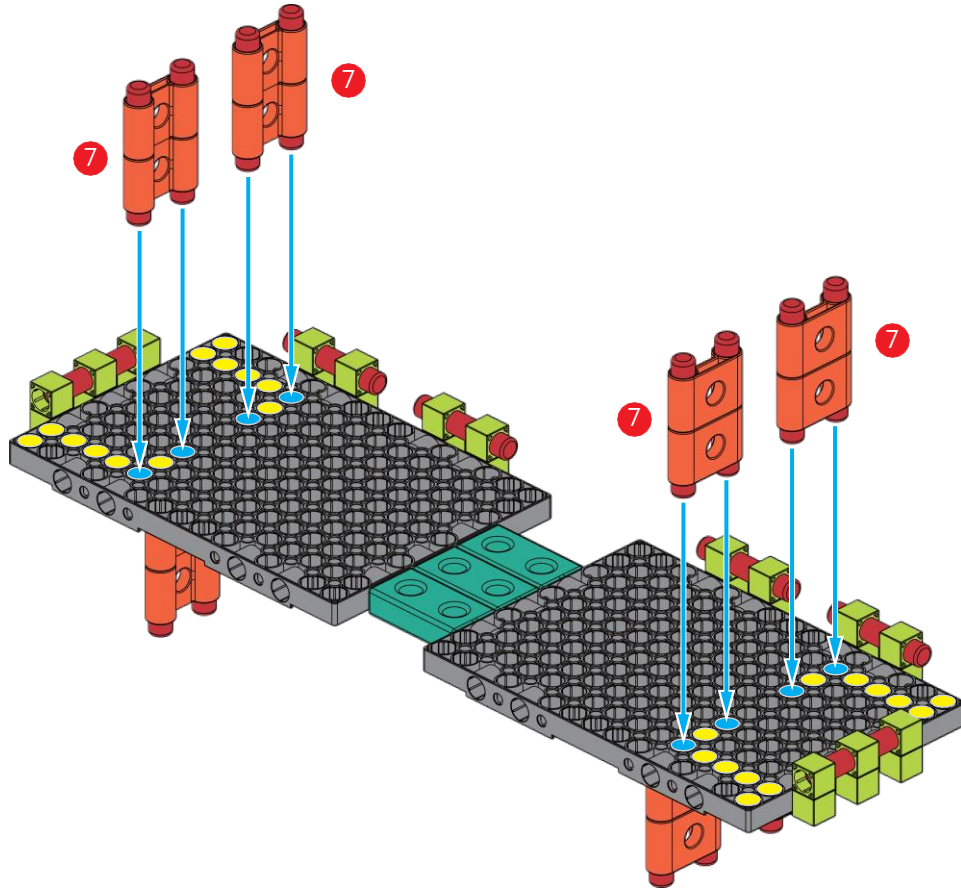
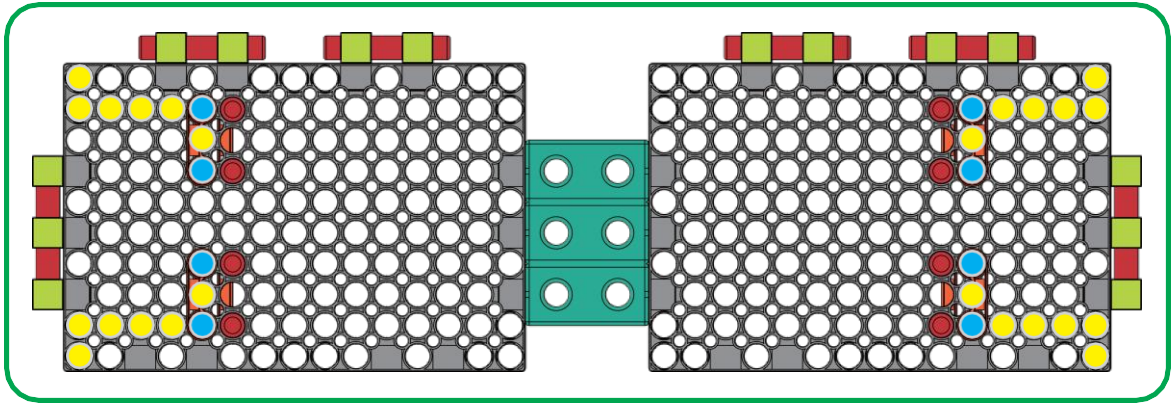

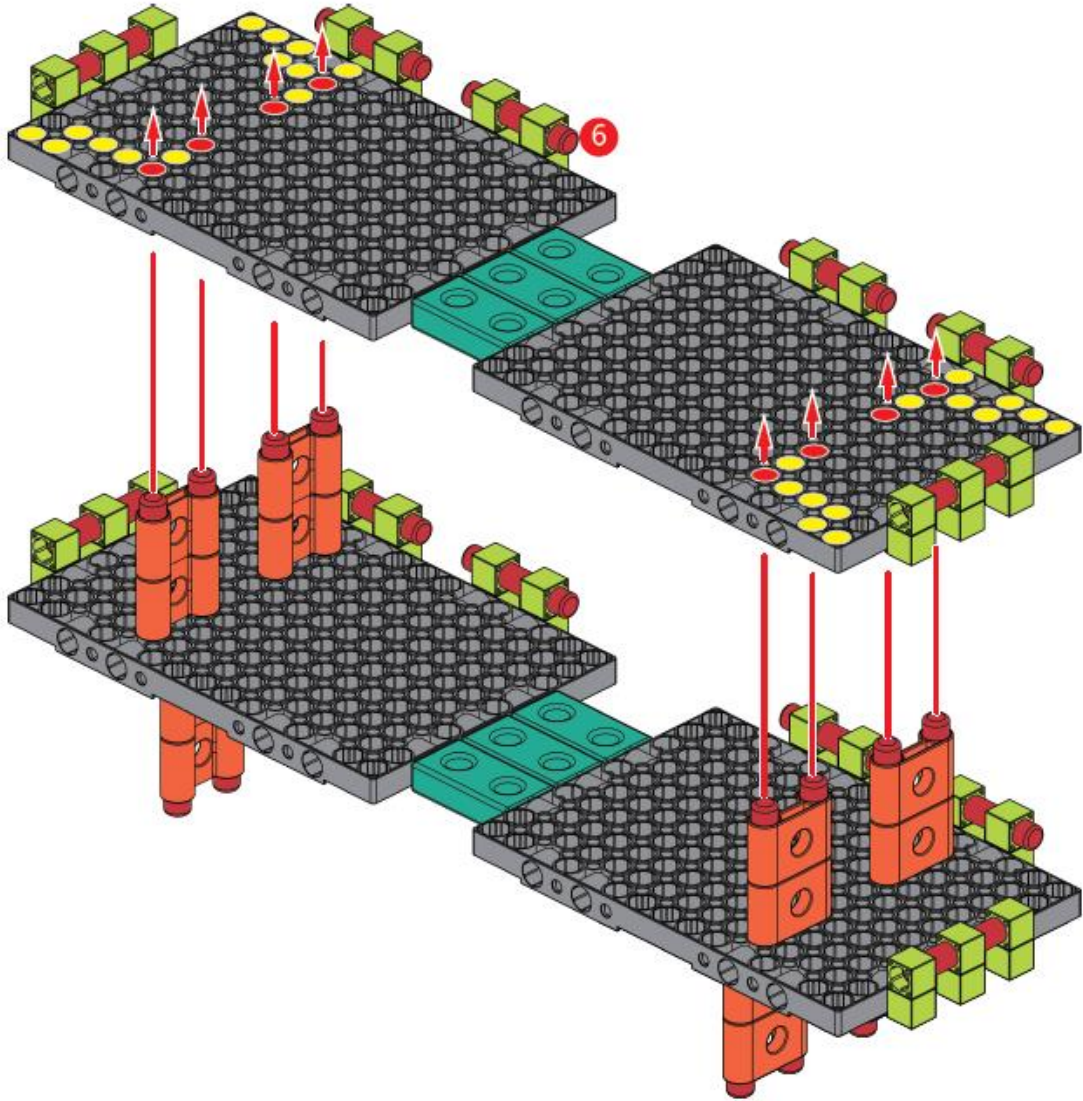
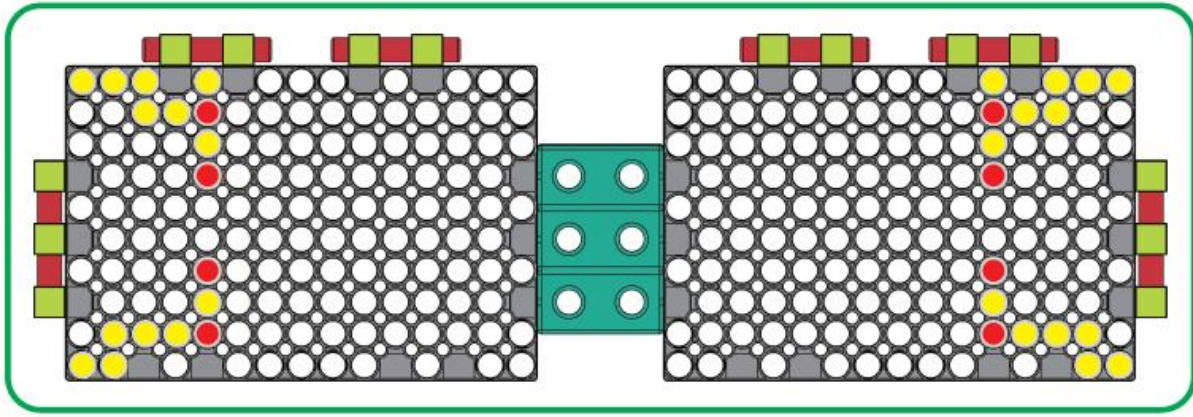

11

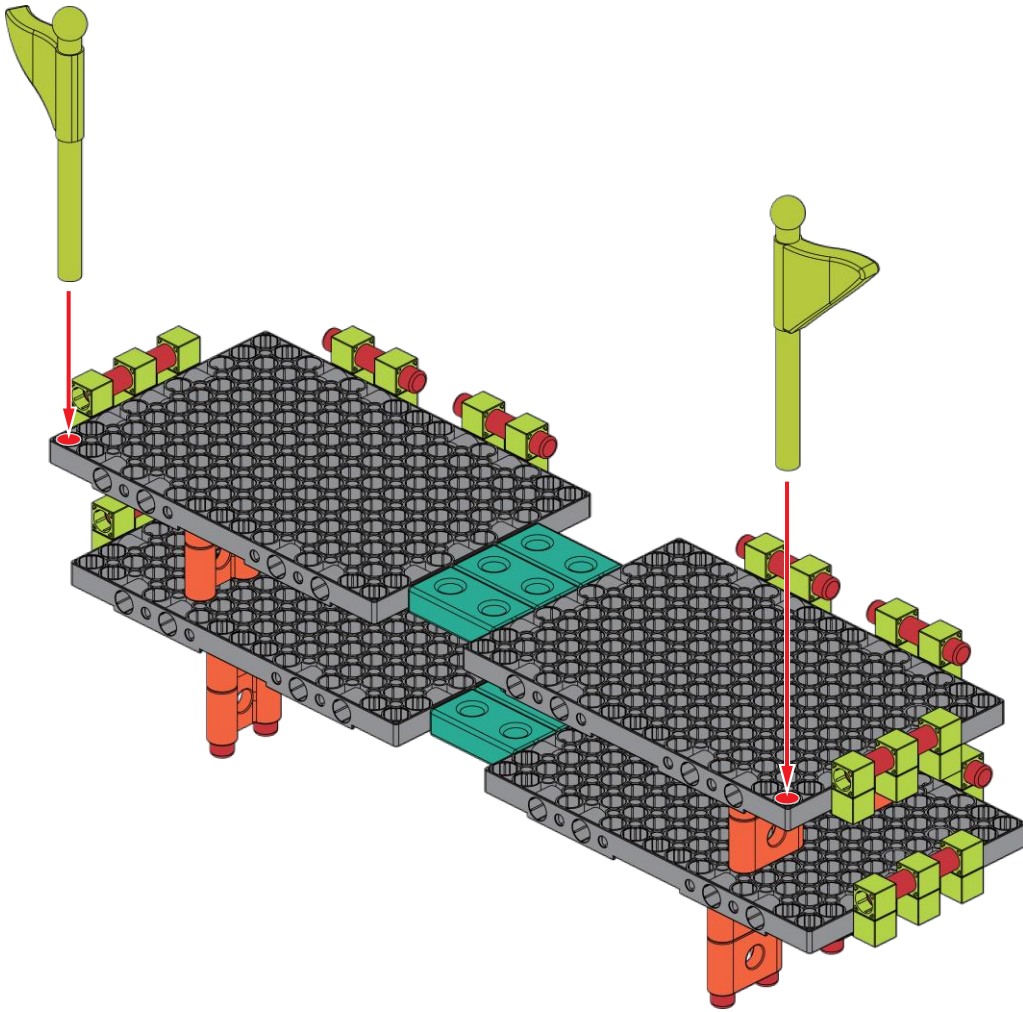

OK STEP. 3

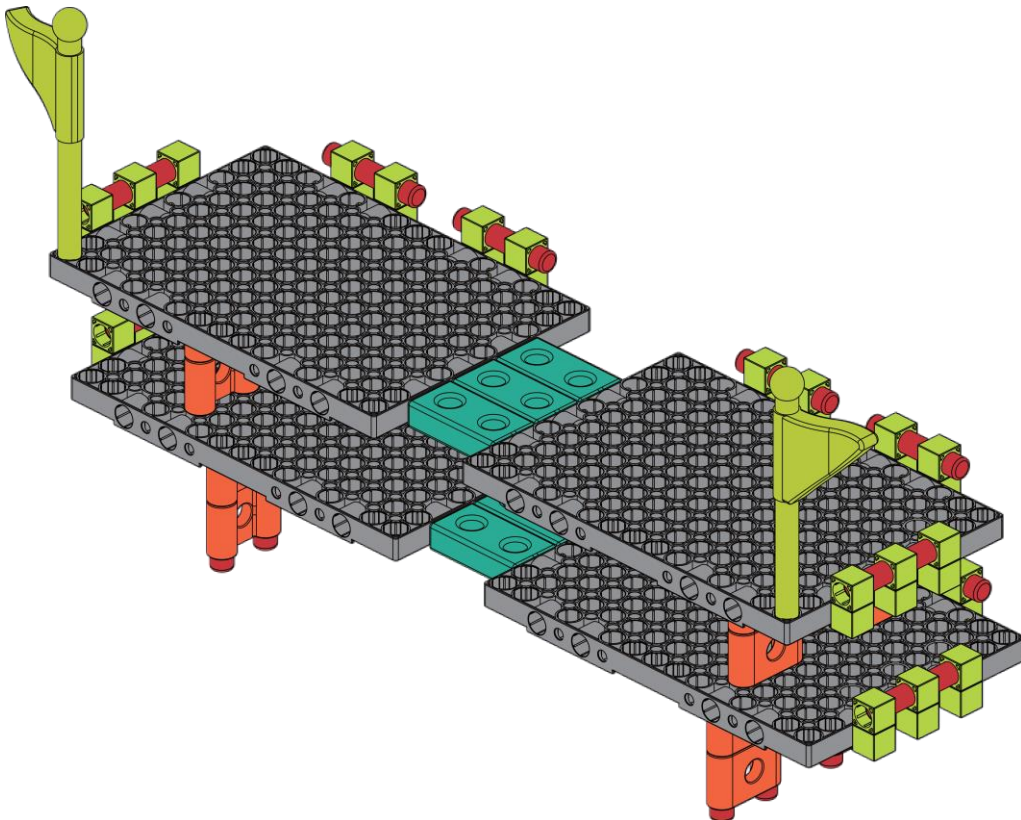

3



x8

4



x1

9

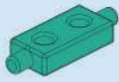

x4

12

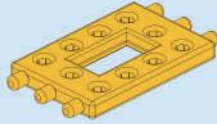

x1

1

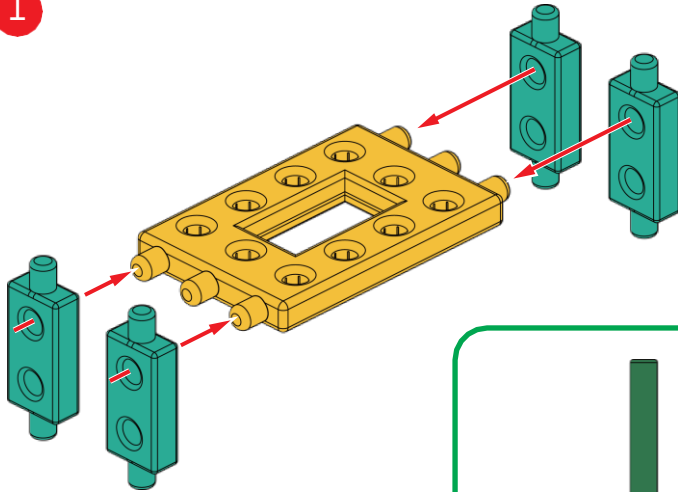

2

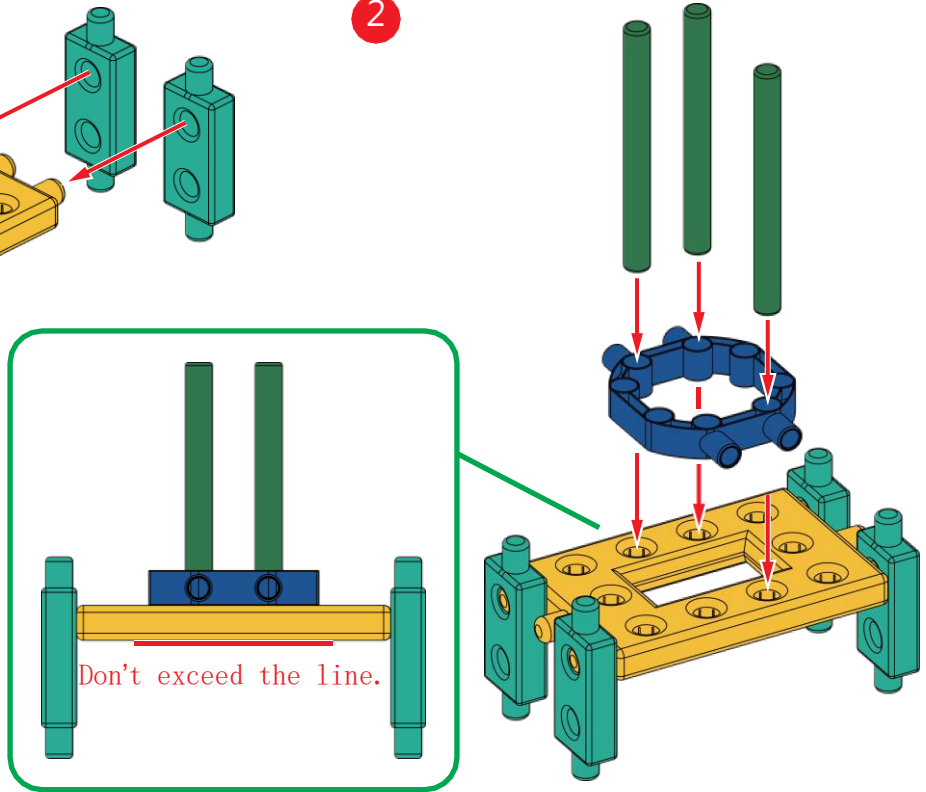

3

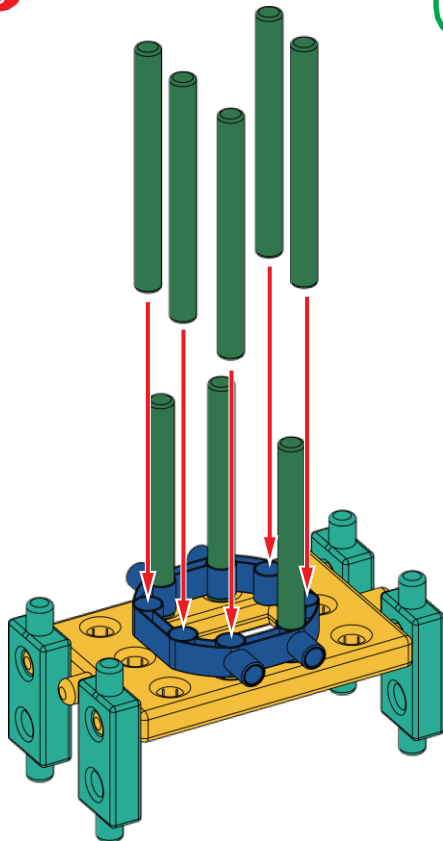

OK STEP. 4

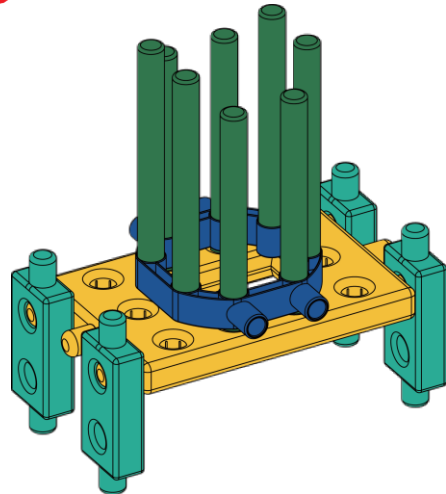

1



x8

7



x4

26

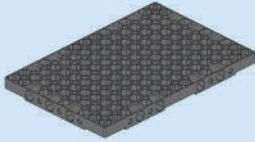

x1

1 x4

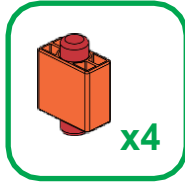

2

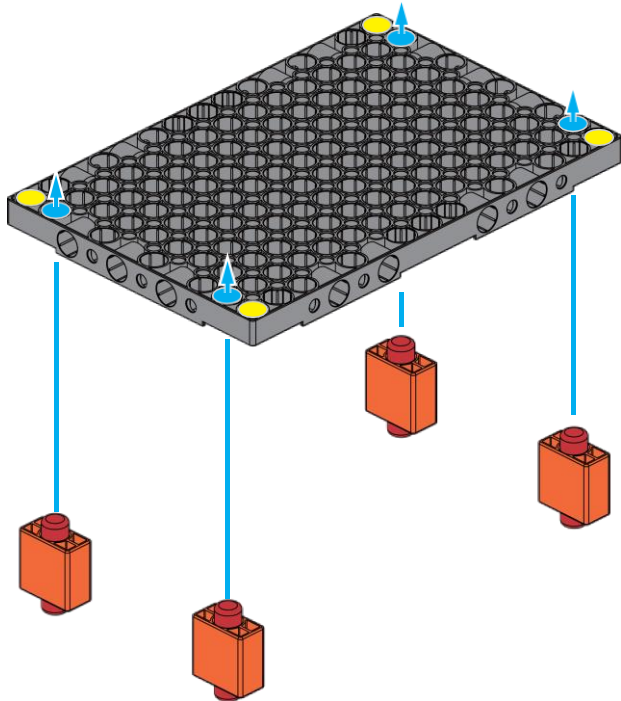
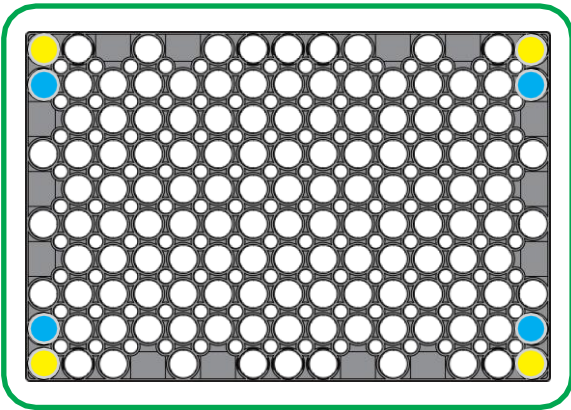

OK STEP. 5

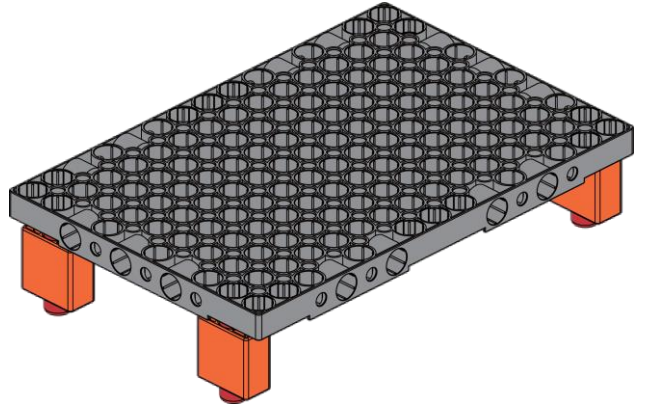

11

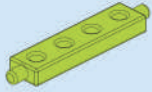

x4

13

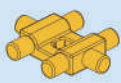

x4

1 x4

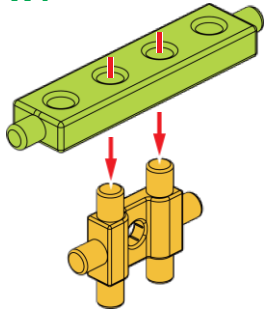

OK STEP. 6

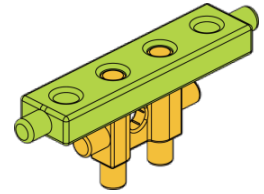
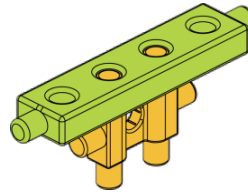
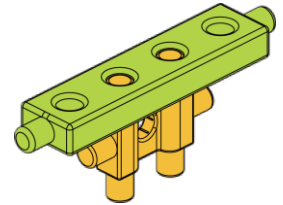
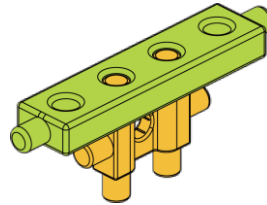

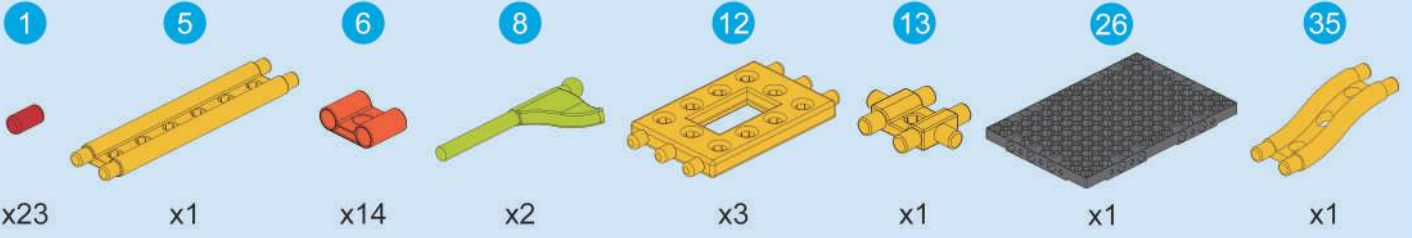

1

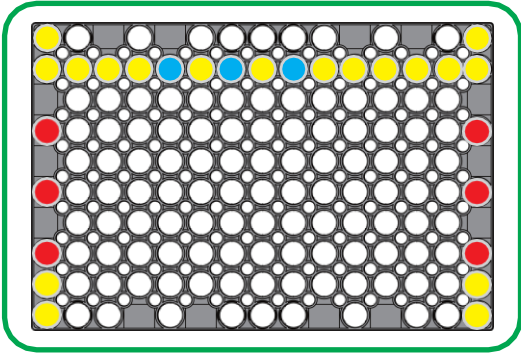

2 x10

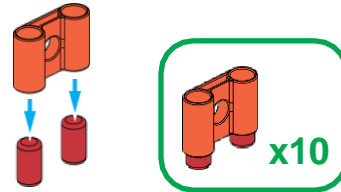

3

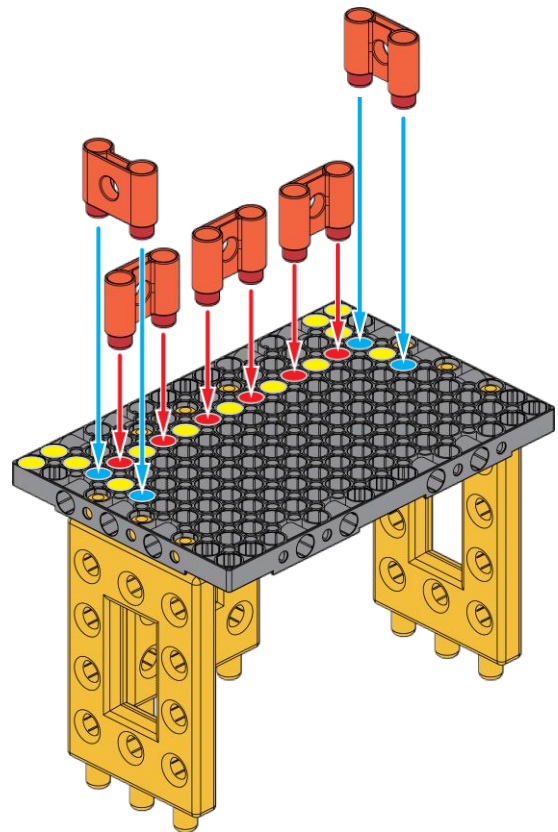
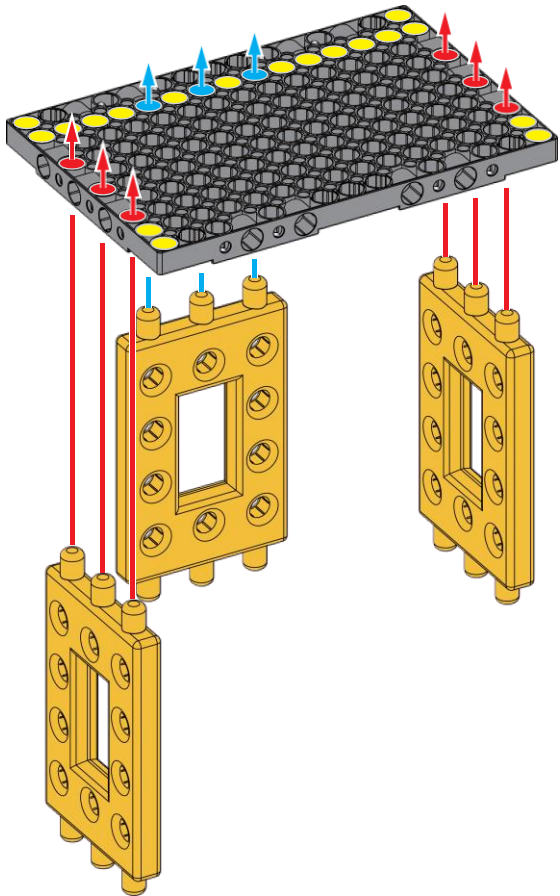
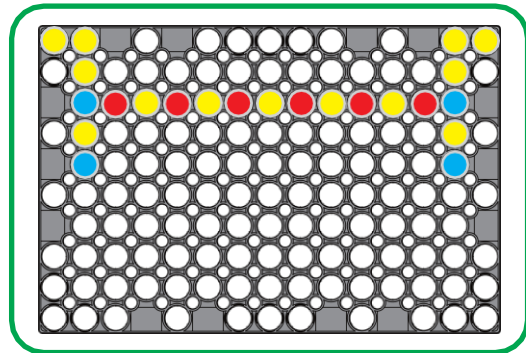

4

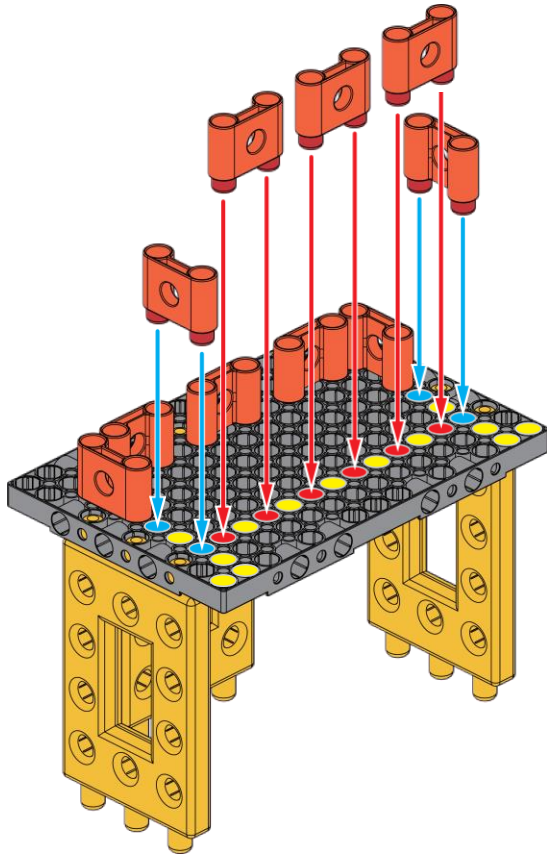
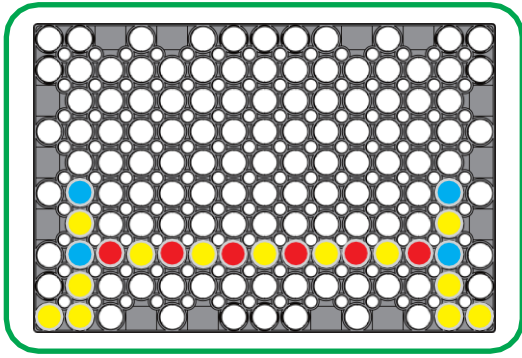

5

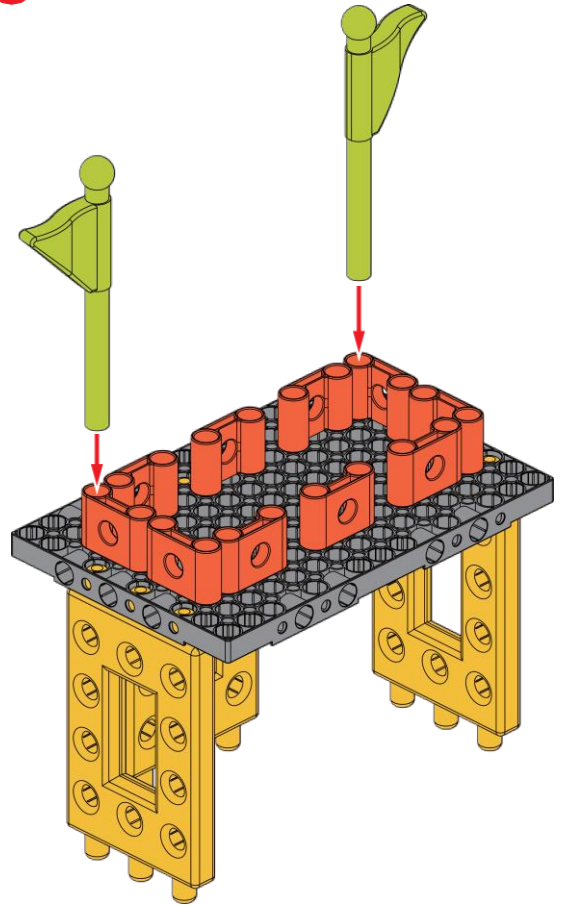

OK STEP. 7-1

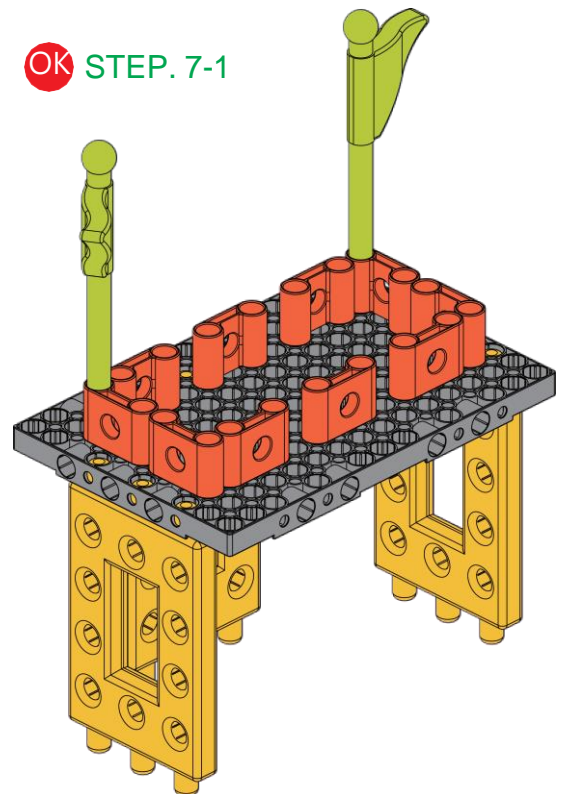

6

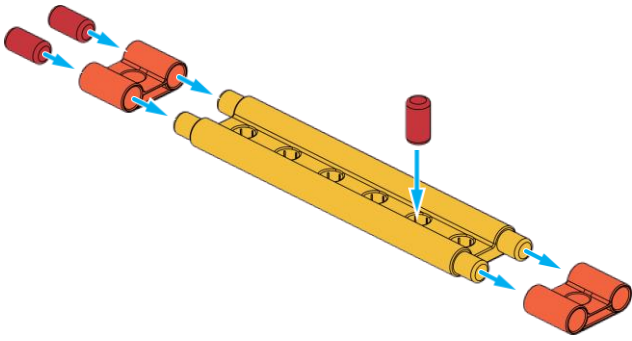

7

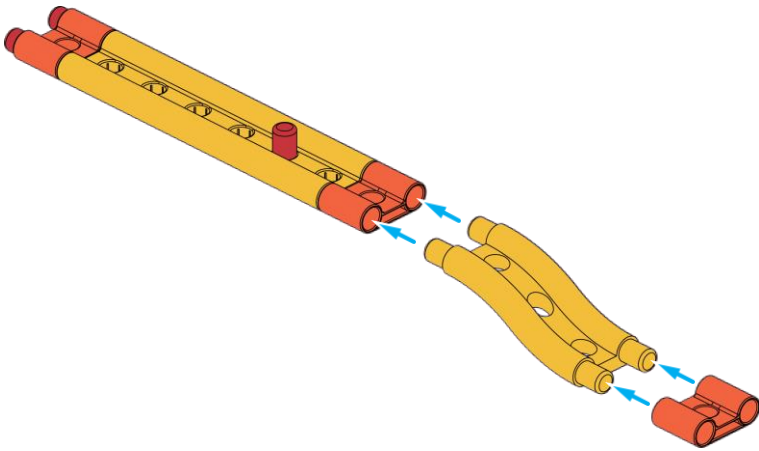

8

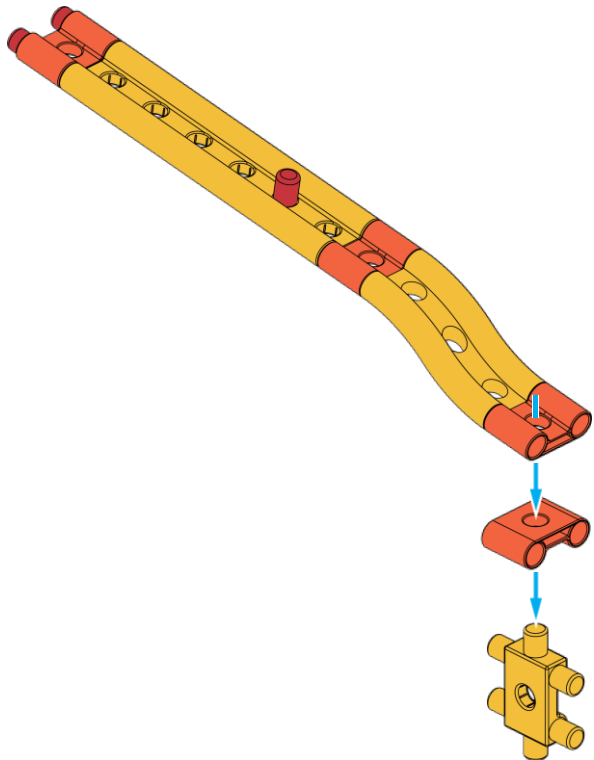

OK STEP. 7-2

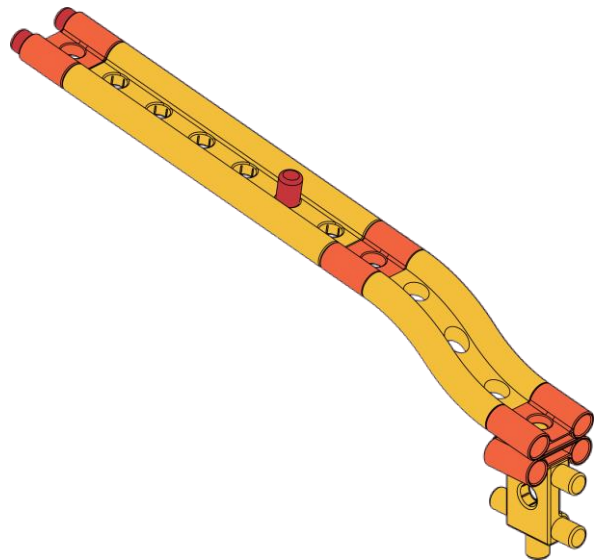

3



x1

11

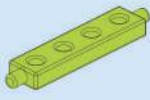

x5

12

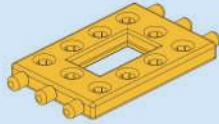

x2

1 x2

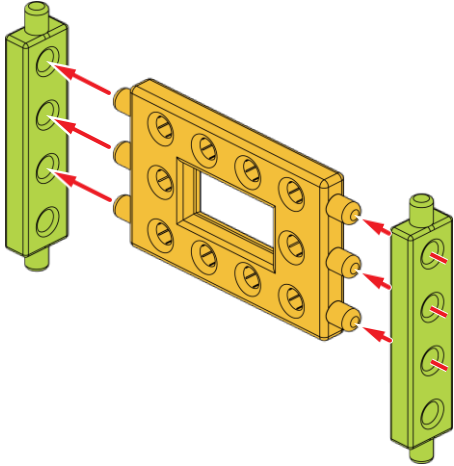

OK STEP. 8-1

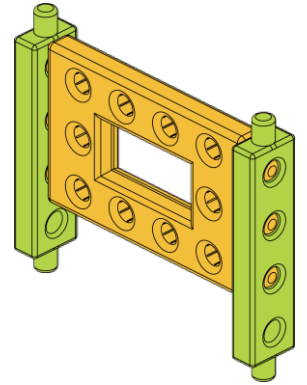
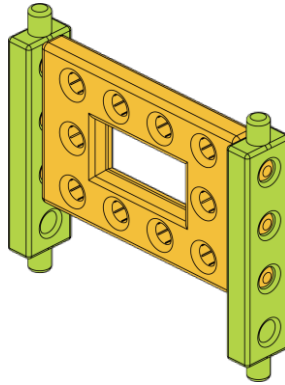

2

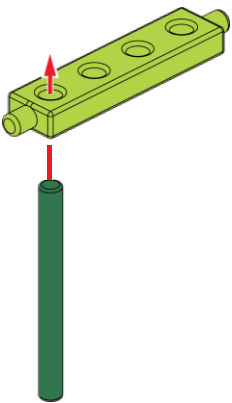

OK STEP. 8-2

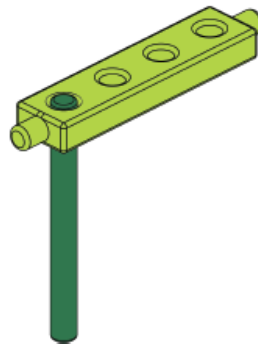

28

29

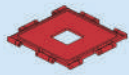

x8

x8

1

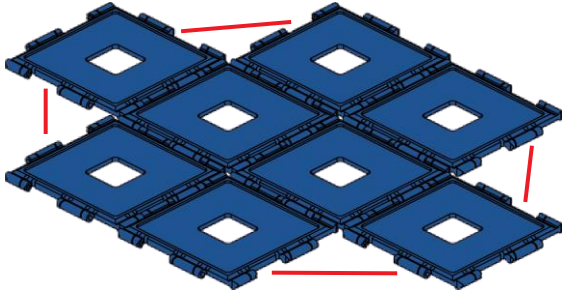

2

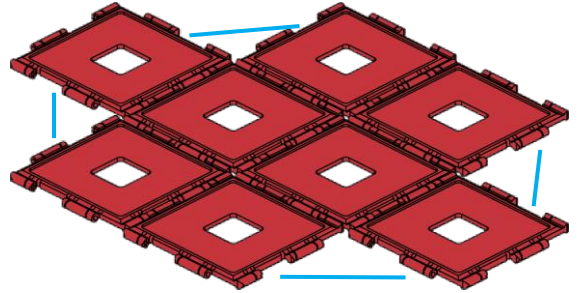

OK STEP. 9

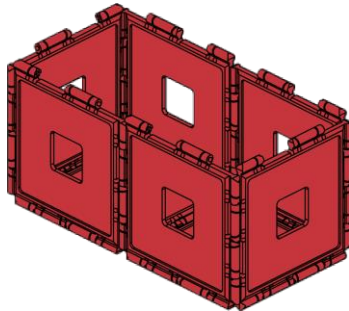
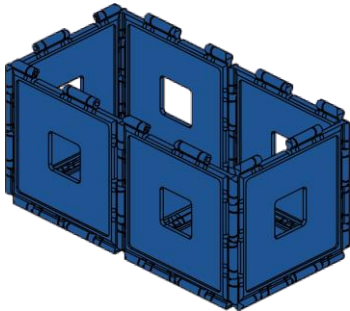

17



x3

18



x3

19



x3

22



x4

23



x4

24



x4

1

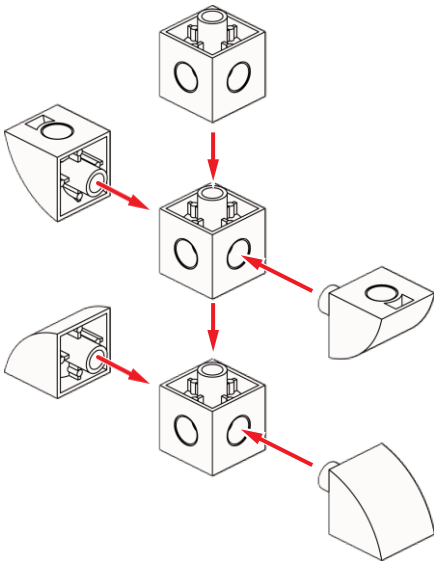

2

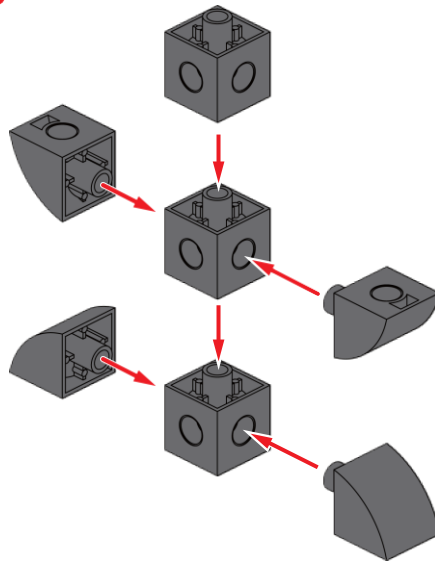

3

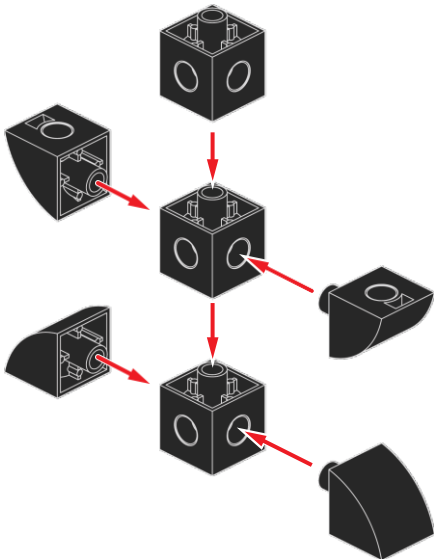

OK STEP. 10

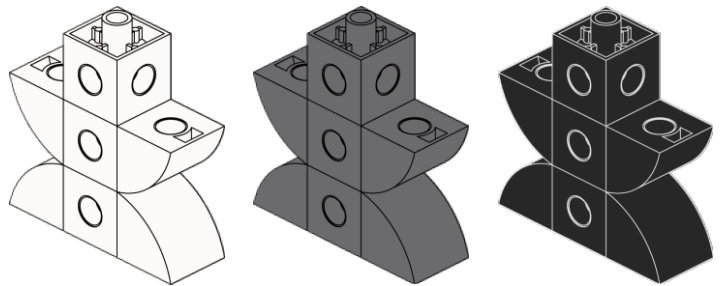

15



x4

16



x4

20



x4

21



x4

1

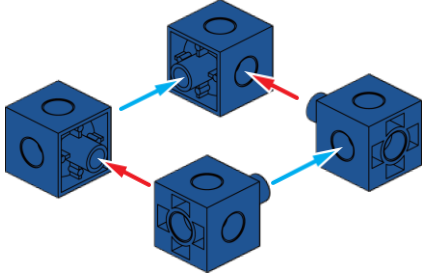

(1) Red line first
(2) Blue line second

2

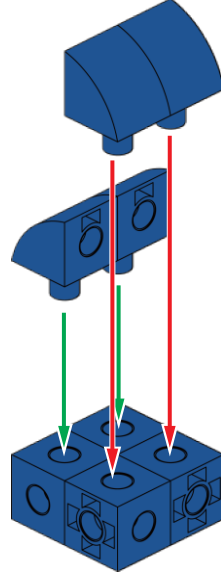

OK STEP. 11

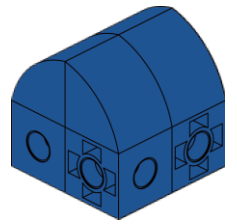

3

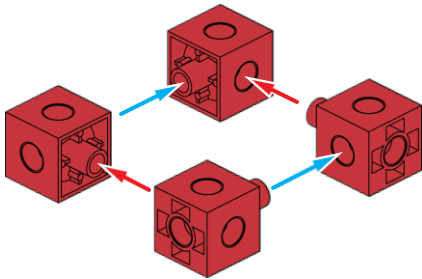

(1) Red line first
(2) Blue line second

4

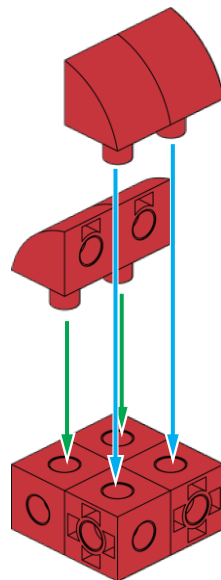

OK STEP. 11

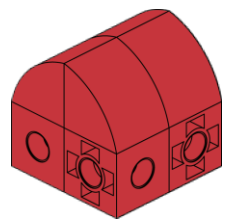

15



x6

16



x6

20



x12

21



x12

25



x8

1 x2

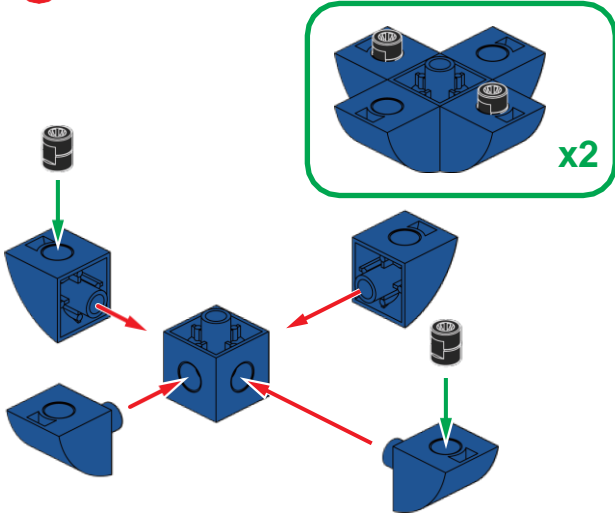

2

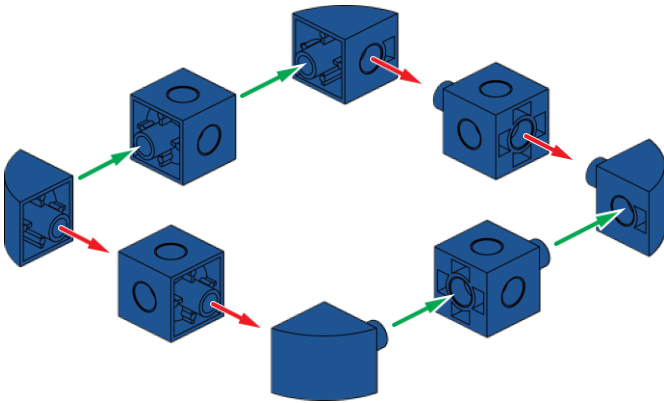

3

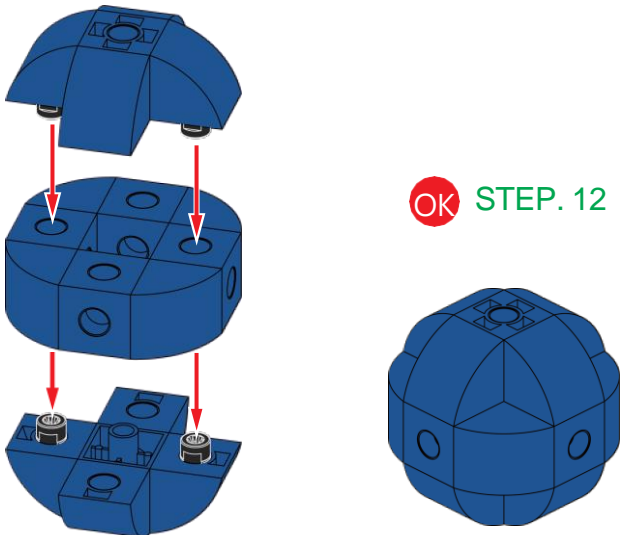

4 x2

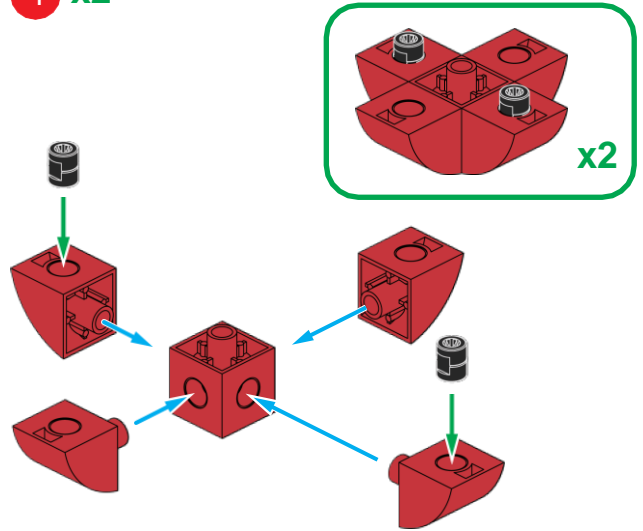

5

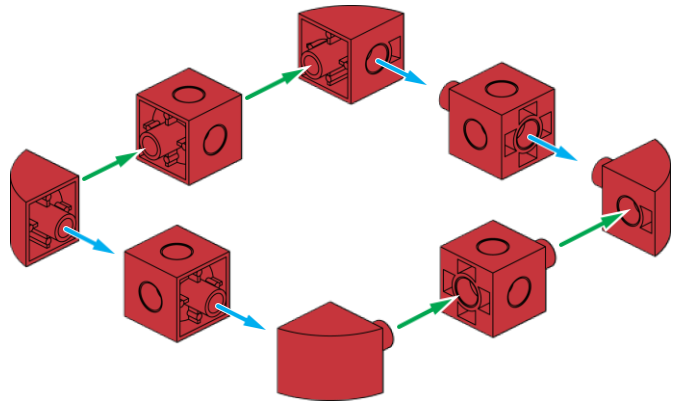

6

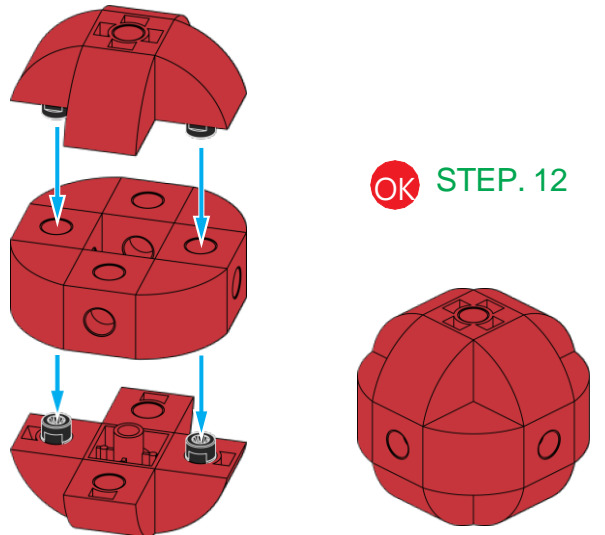

1

7



x12

x6

1 x6

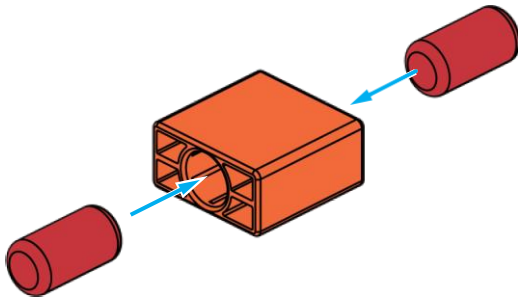

OK STEP. 13

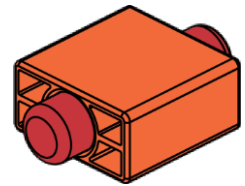
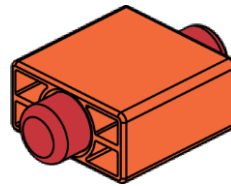
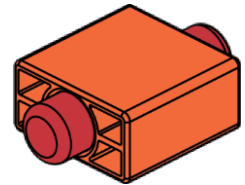
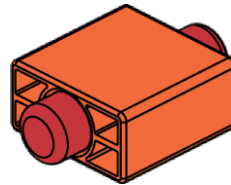
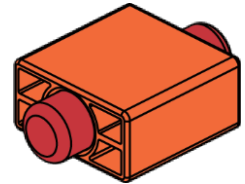
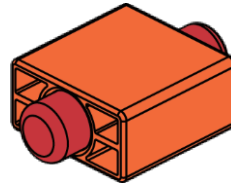

25

30

31

32



x6

x3

x3

x3

1 x3

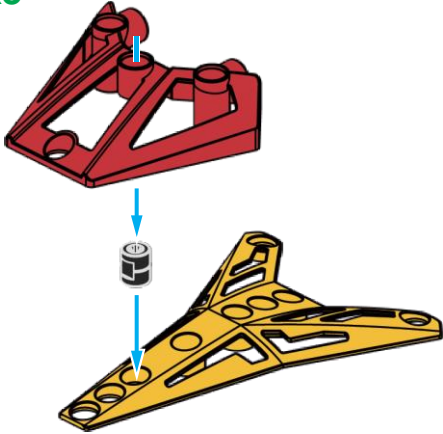

2 x3

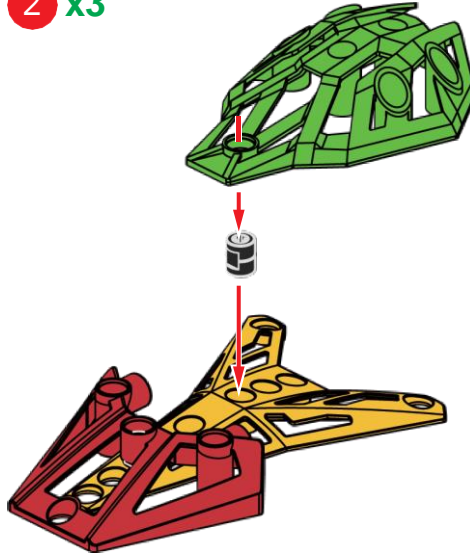

OK STEP. 14

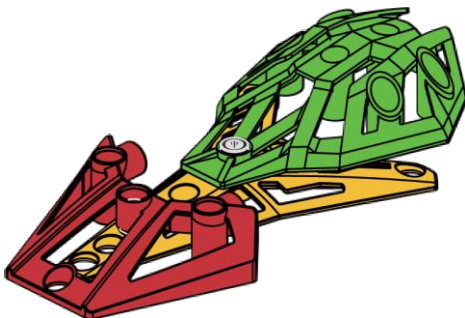
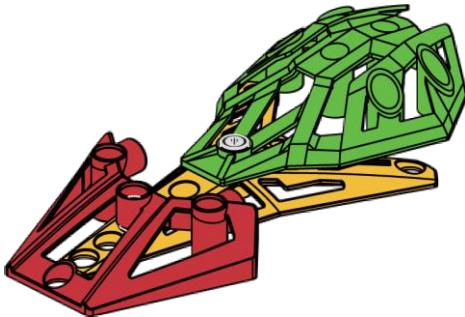
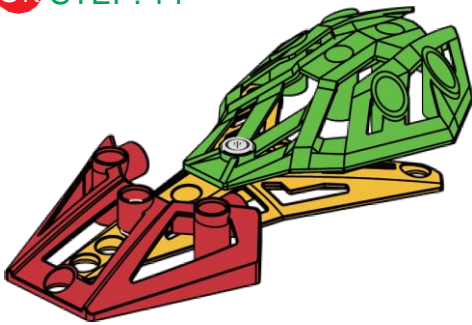

25

30

31

33



x6

x3

x3

x3

1 x3

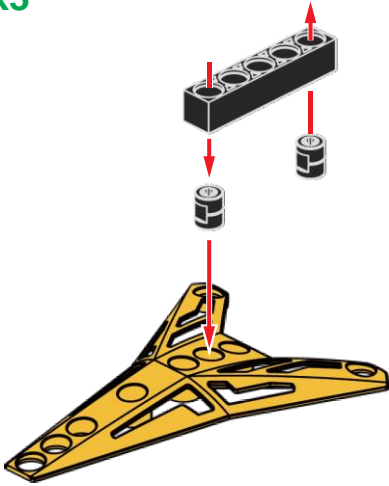

2 x3

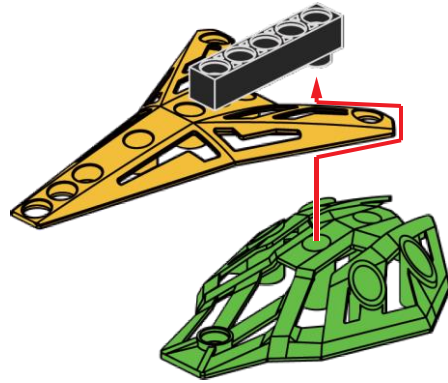

OK STEP. 15

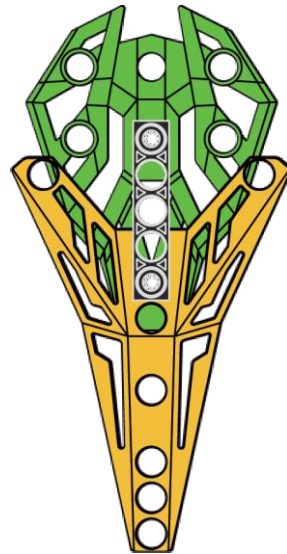
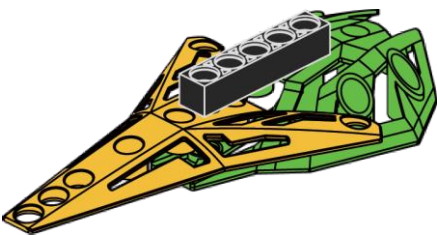
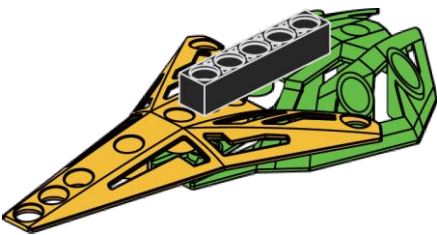
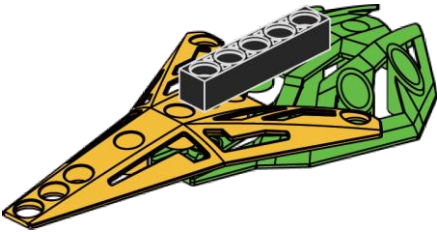

2



x4

37



x8

38



x3

2024 R4M advanced map

1



2



3

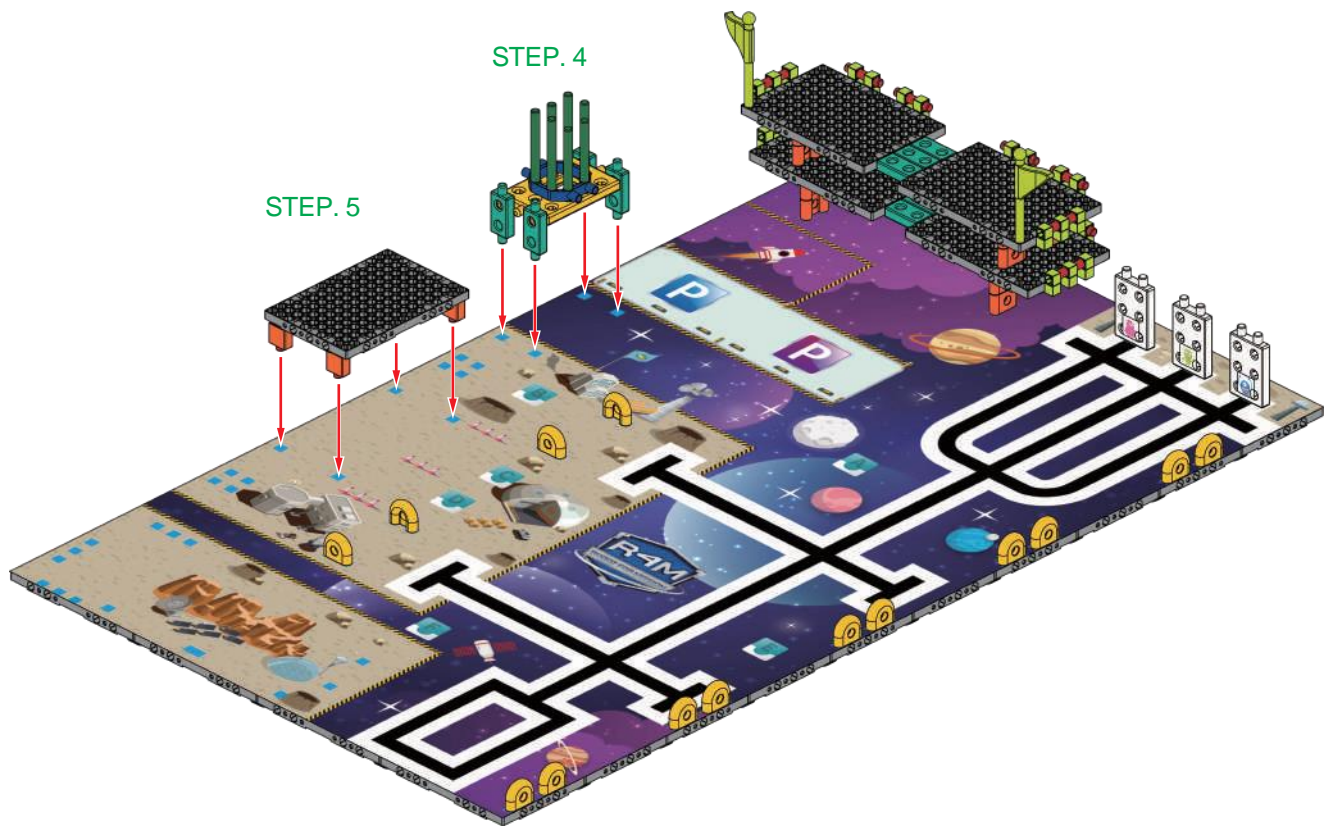

4



5

STEP. 7-1

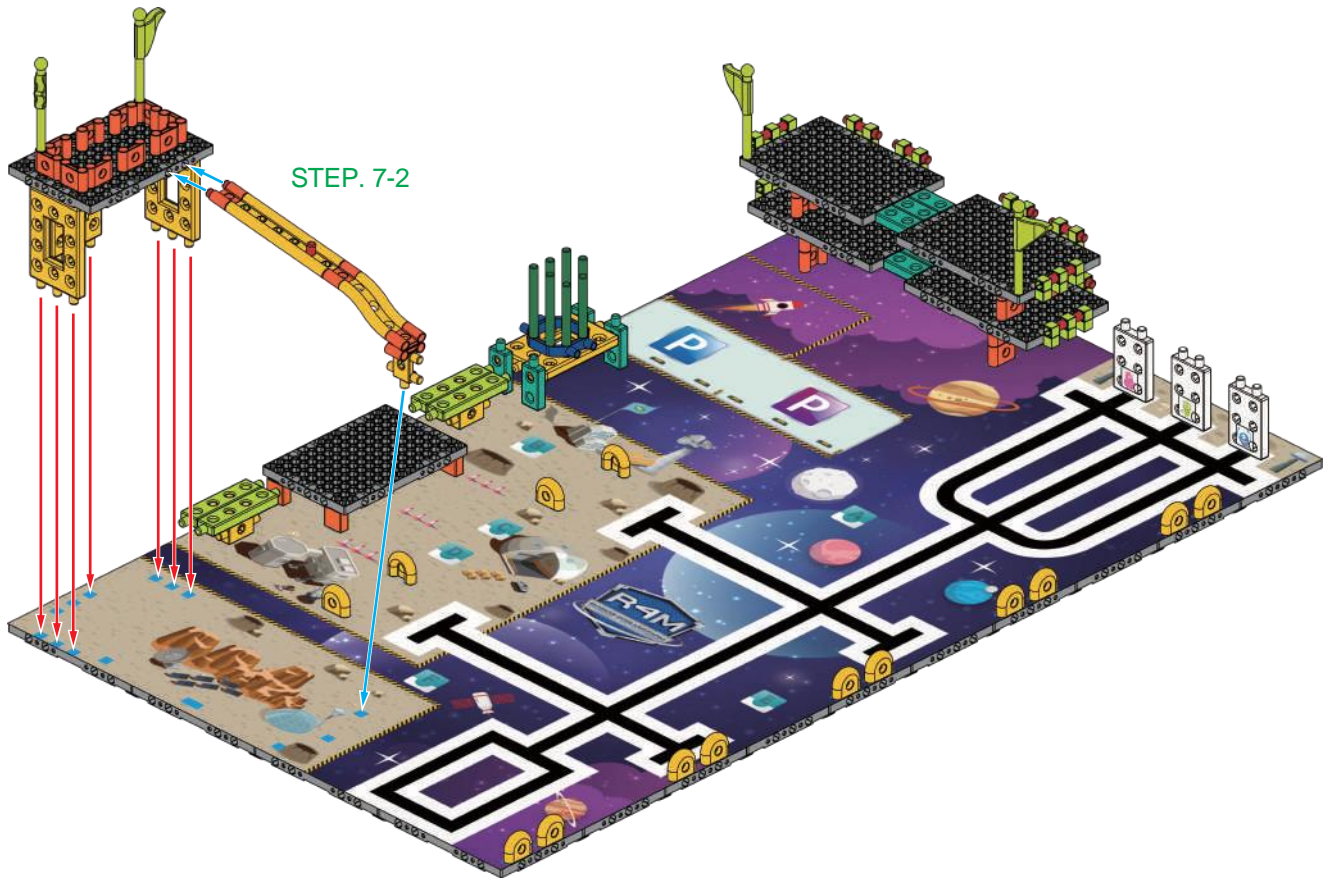

6

STEP. 8-1

STEP. 8-1

STEP. 8-2

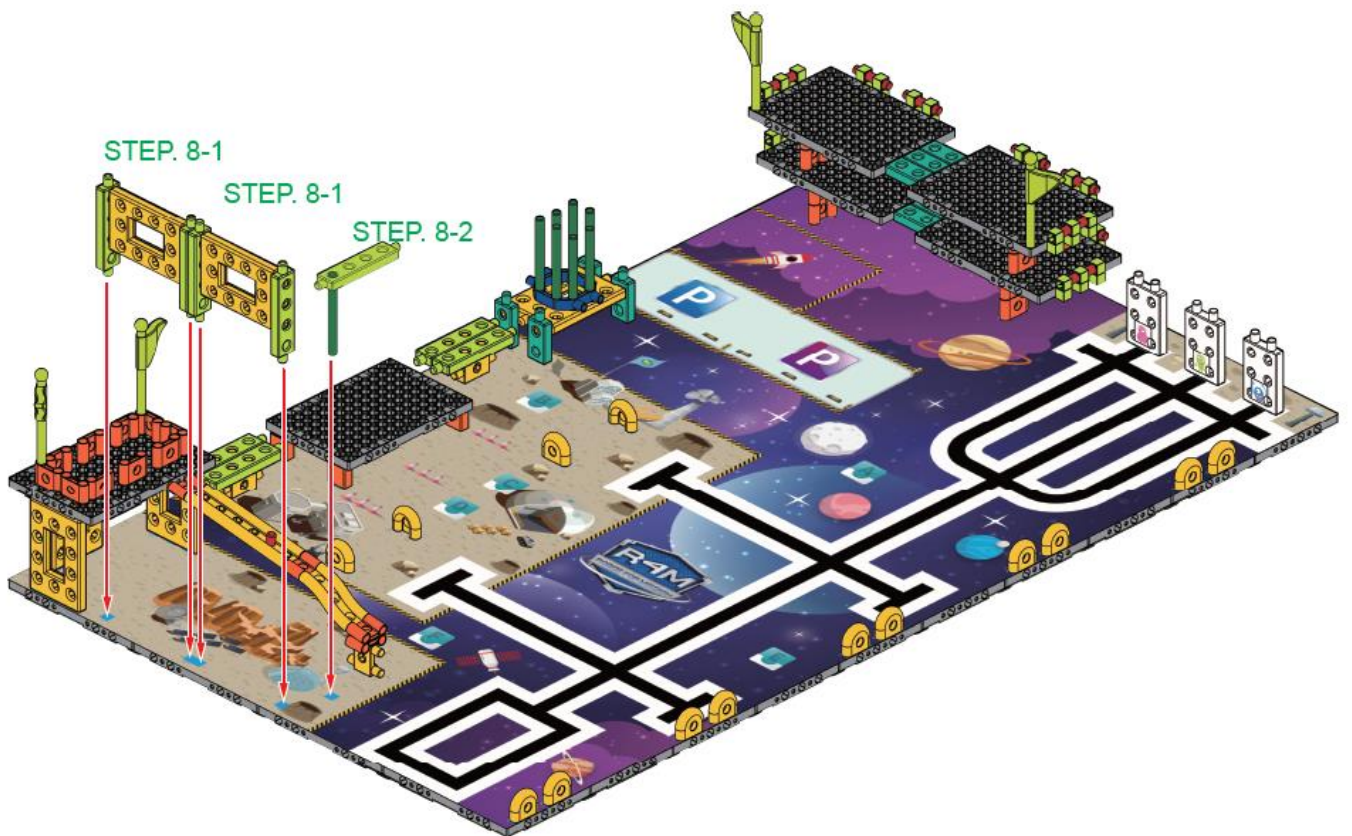

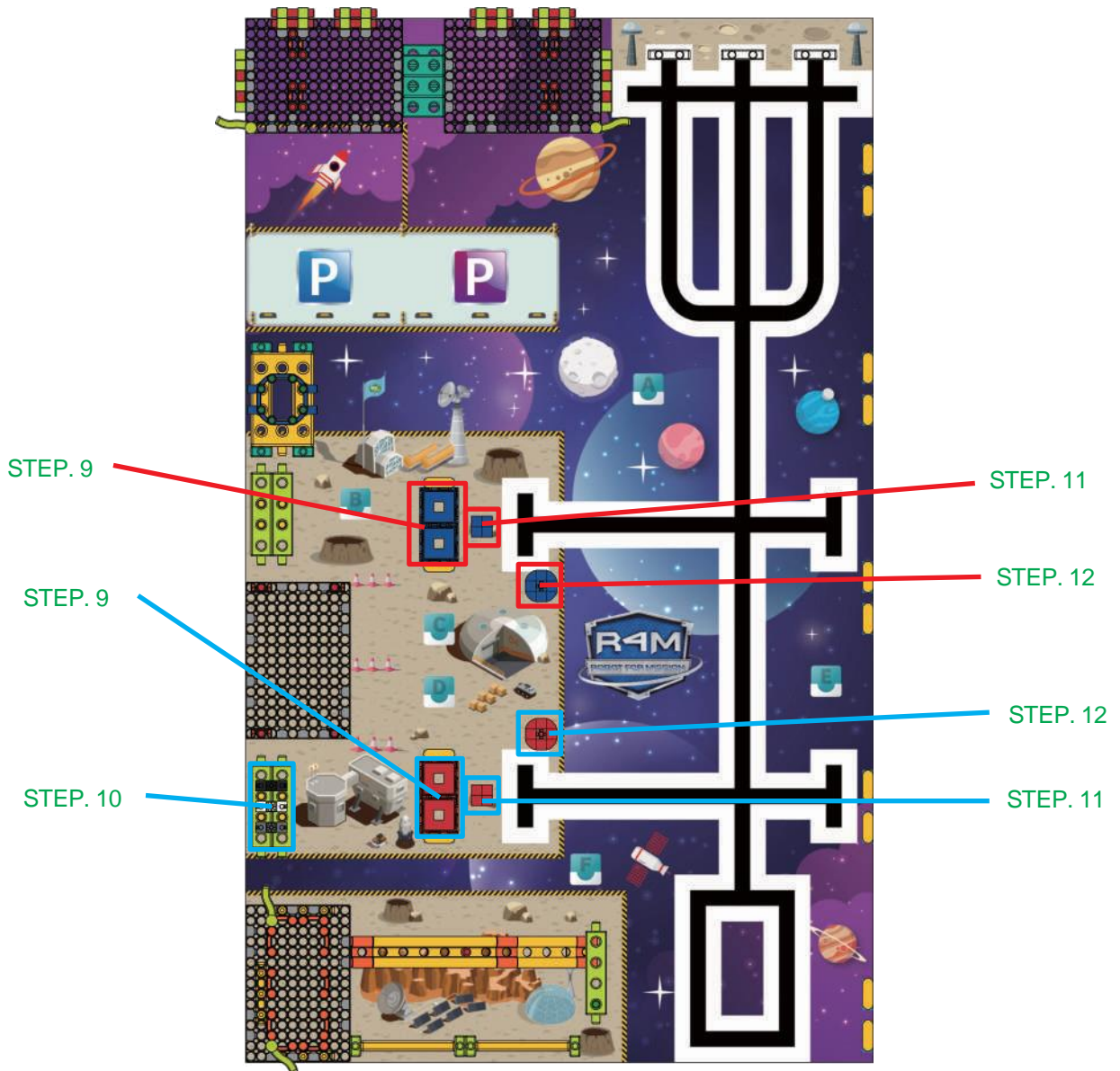
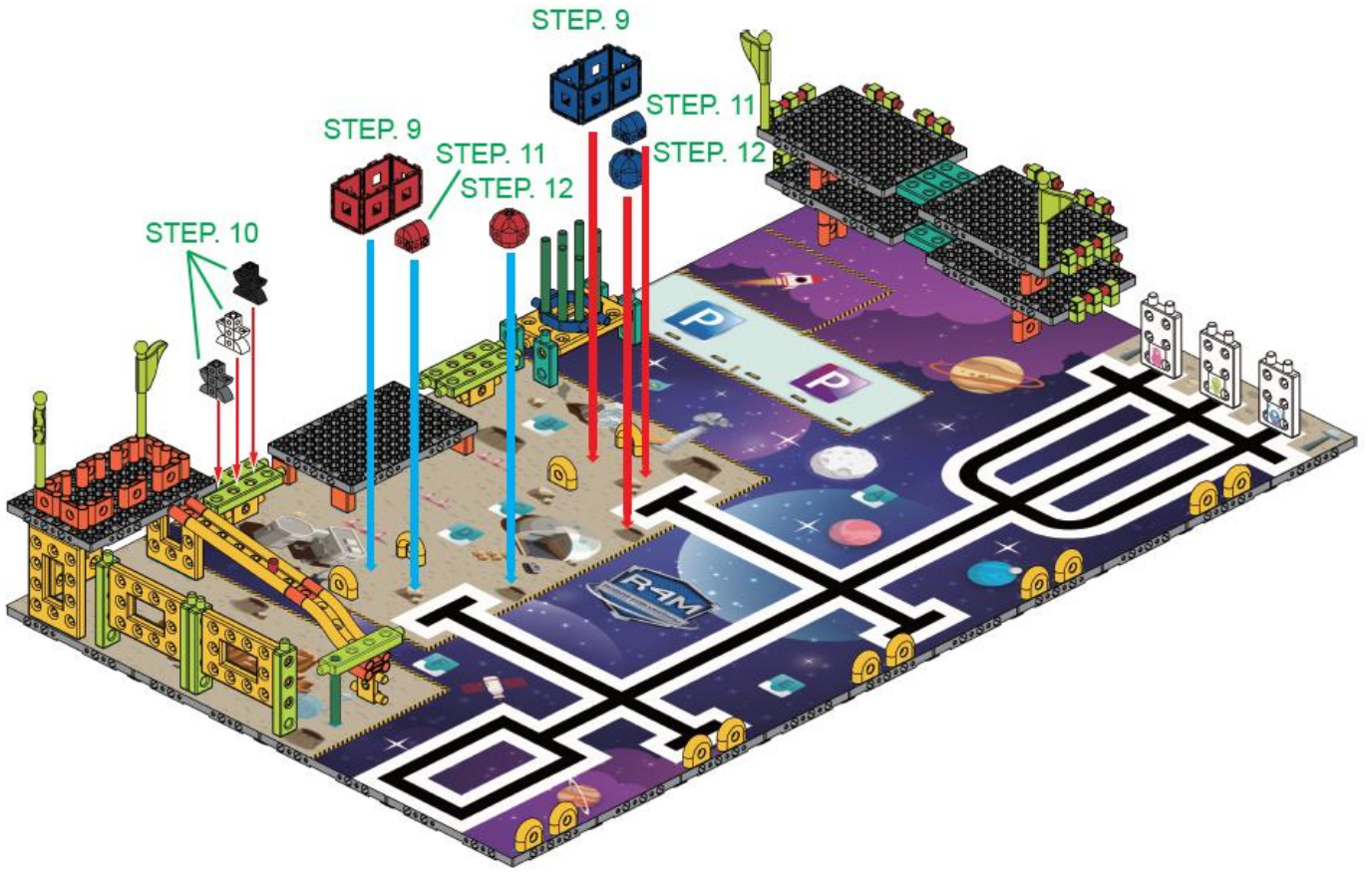

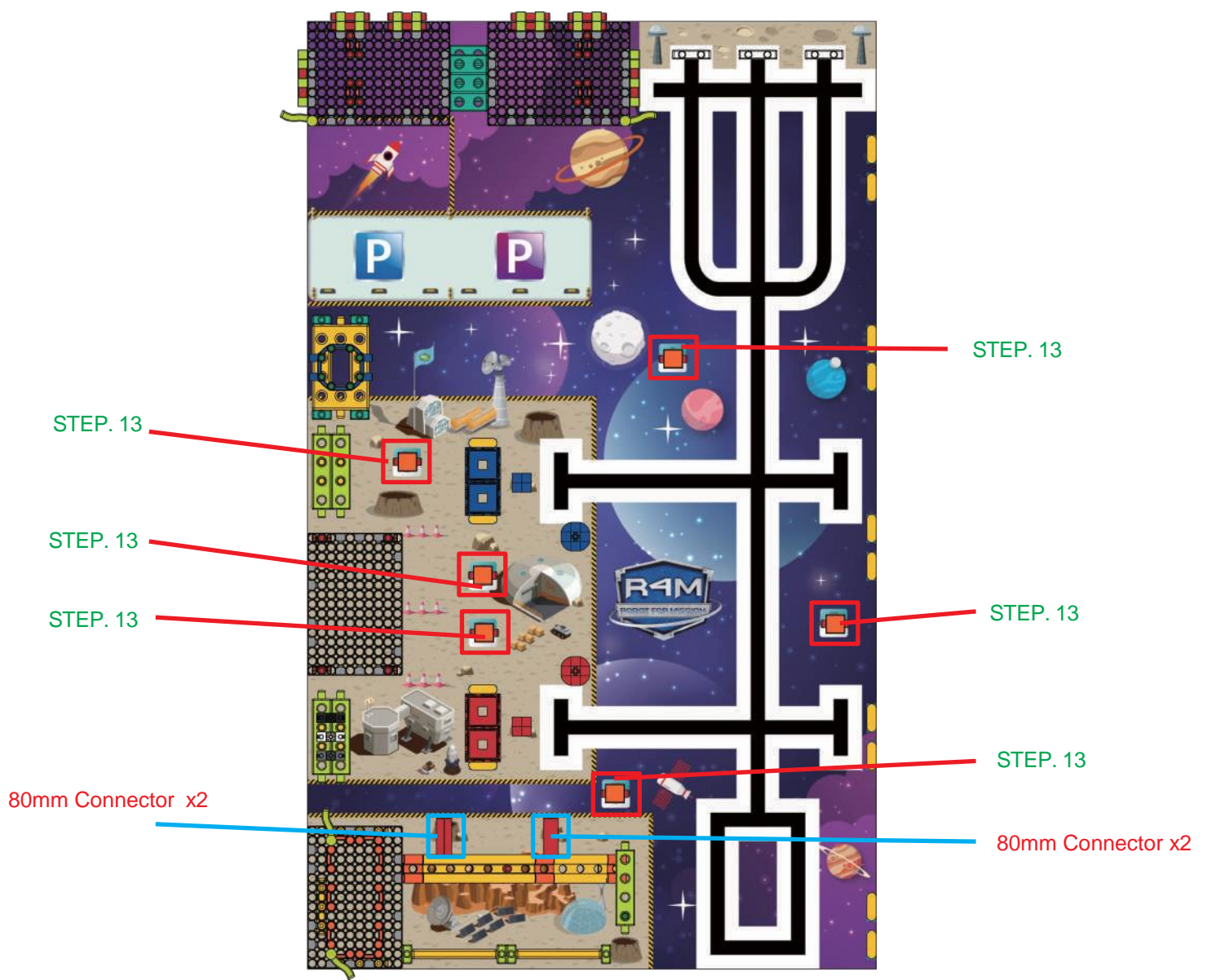
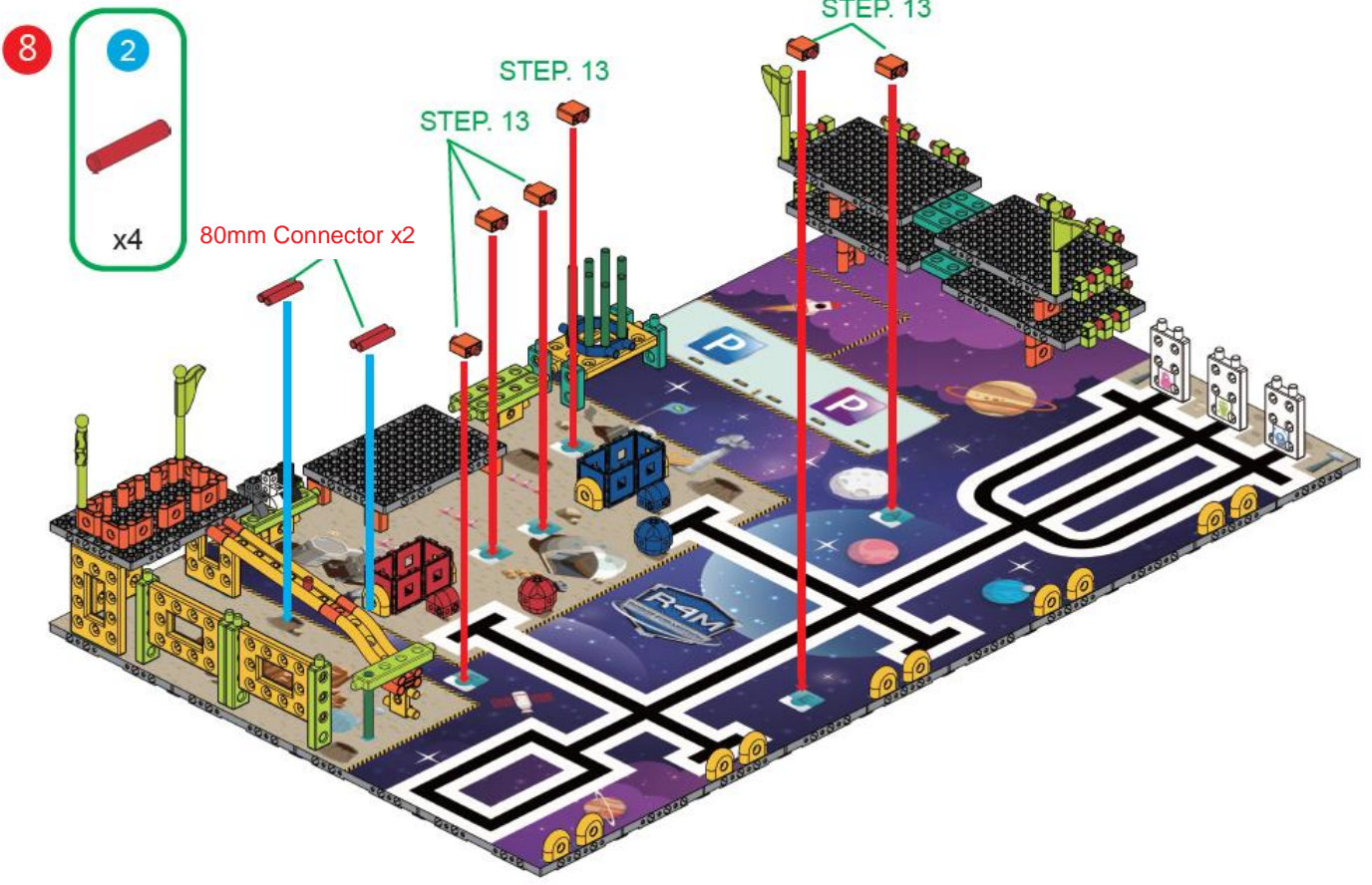

9

37	38
	
x8	x3

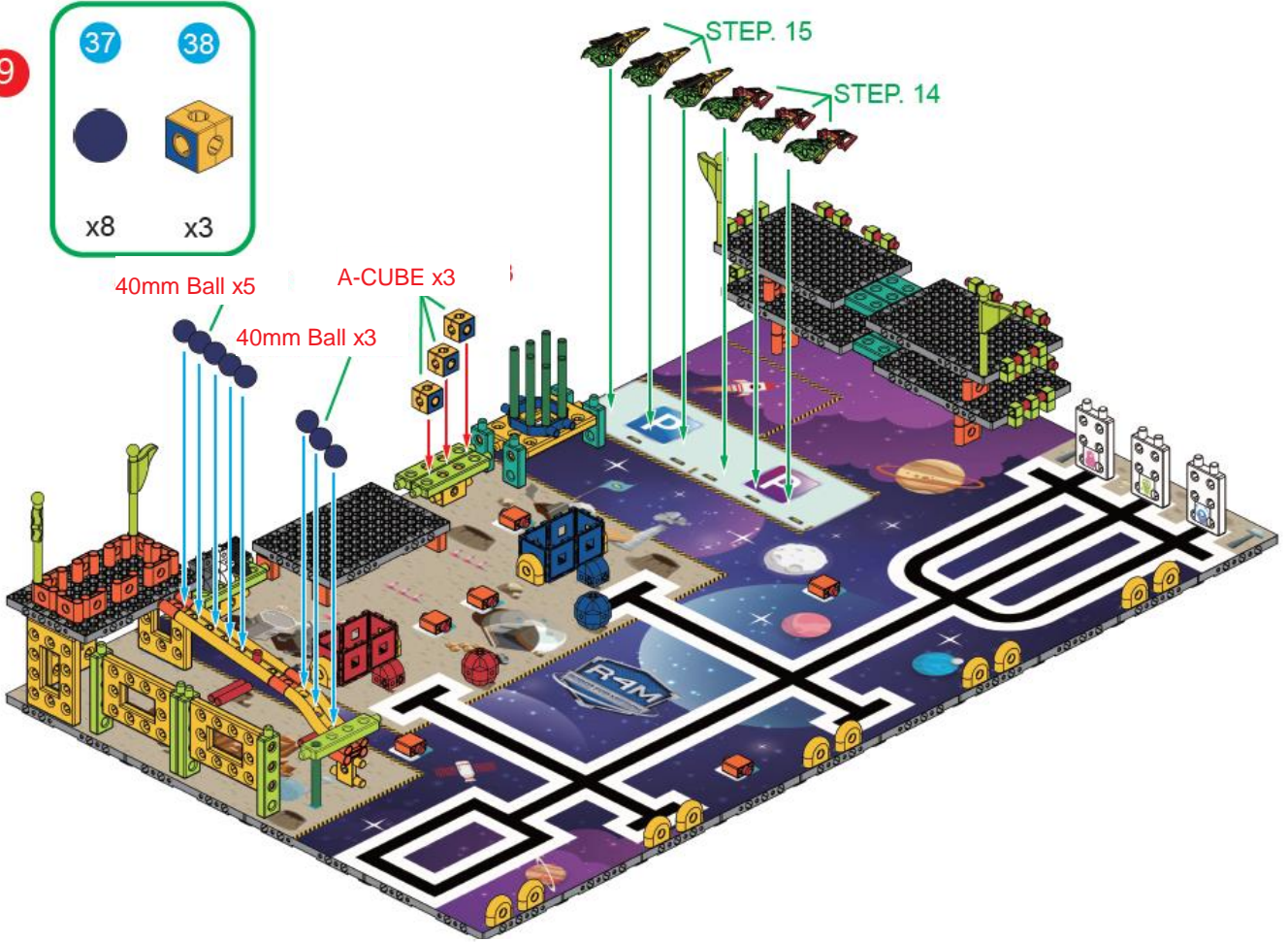

40mm Ball x5

A-CUBE x3

40mm Ball x3

STEP. 15

STEP. 14

STEP. 15 STEP. 14

STEP. 15	STEP. 14	STEP. 14	STEP. 14	STEP. 14	STEP. 14
----------	----------	----------	----------	----------	----------

A-CUBE x3

40mm Ball x3

40mm Ball x5



